

RTWM-614 ANDREWS

Cylindrical roller thrust bearings

TYPE: Roller bearings, Thrust roller bearing, Cylindrical, Single direction, separable, cylindrical rollers, inch sizes, self-aligning

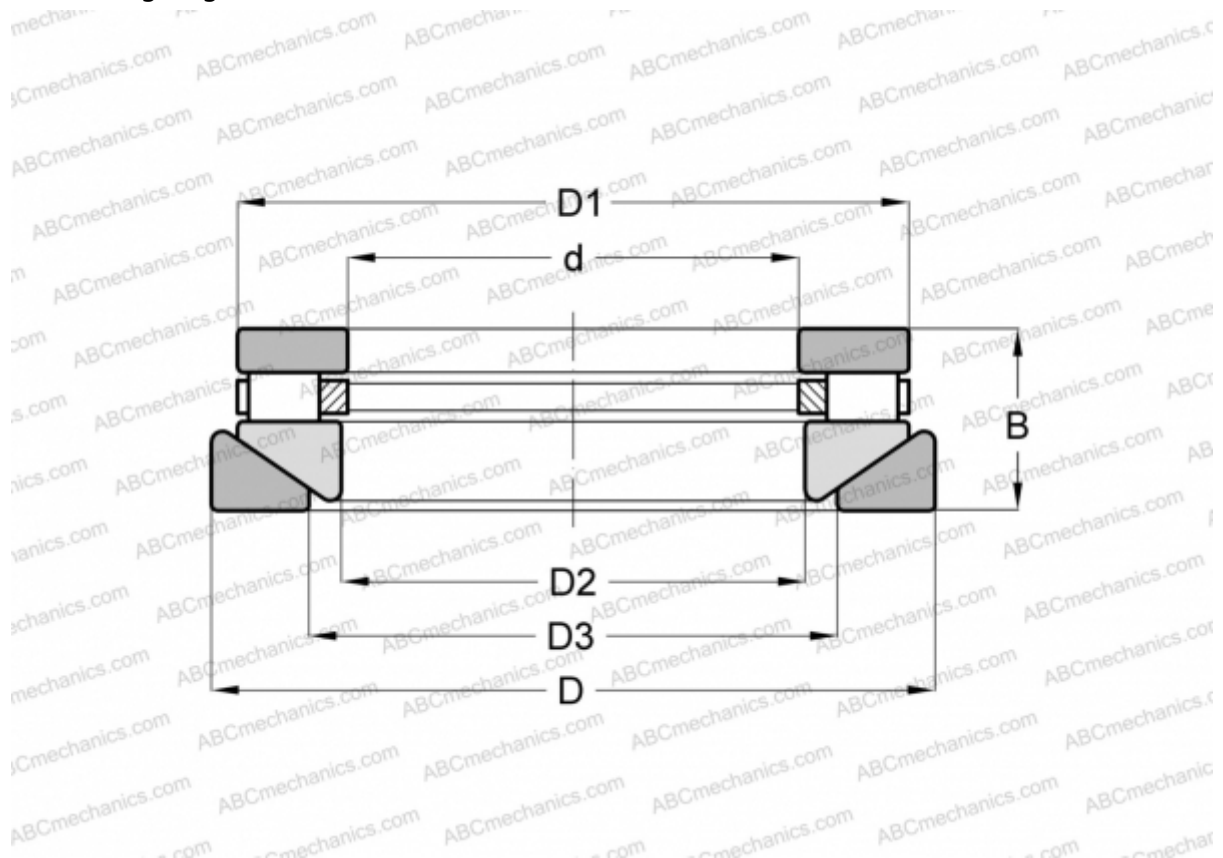

Technical specification

DIMENSIONS, MM

d	46,038
D	88,900
D1	83,820
D2	47,625
D3	52,388
B	33,338

WEIGHT, KG 0,907

MANUFACTURER [ANDREWS](#)

INTERCHANGE

ROLLWAY	AT-614
INA	RTW-614