

RTW-616 INA

Cylindrical roller thrust bearings

TYPE: Roller bearings, Thrust roller bearing, Cylindrical, Single direction, separable, cylindrical rollers, inch sizes, self-aligning

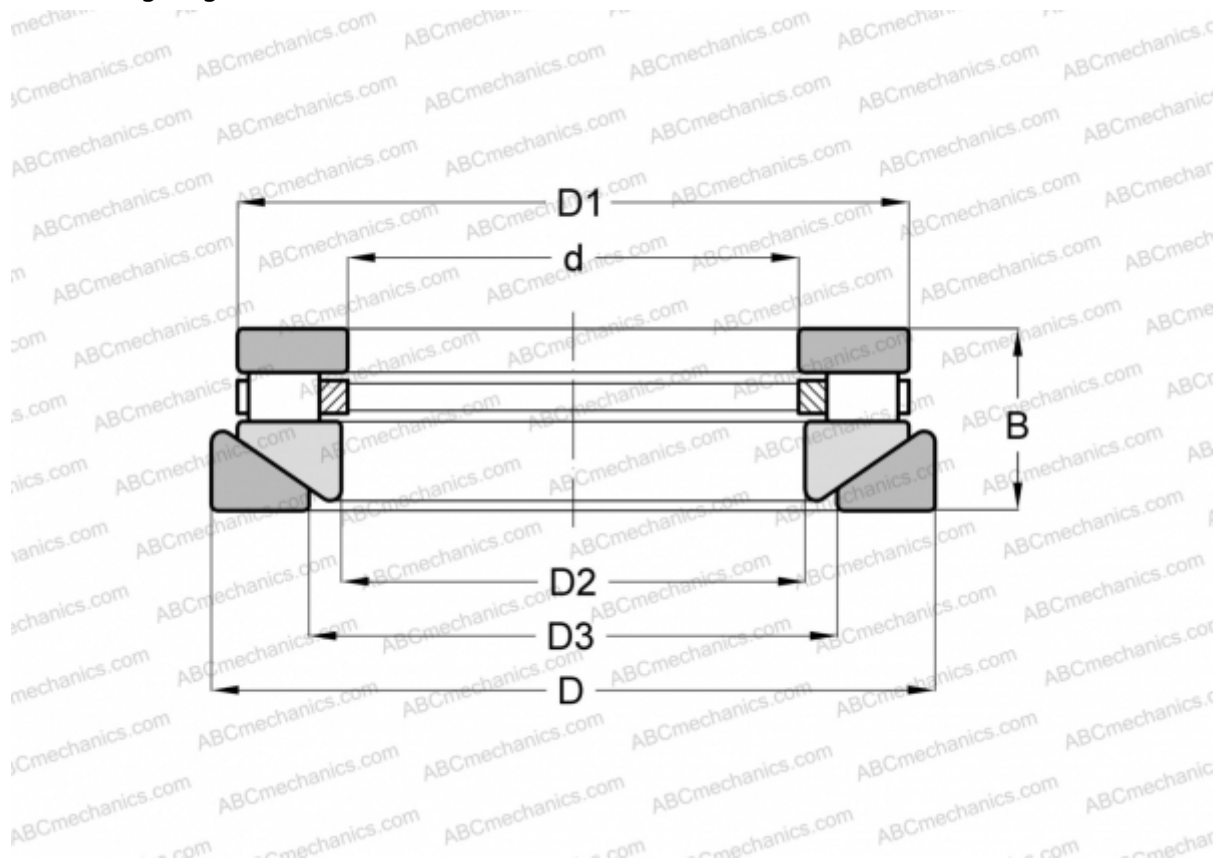

Technical specification

DIMENSIONS, MM

d	49,213
D	92,075
D1	86,518
D2	50,800
D3	57,150
B	33,338

WEIGHT, KG 0,998

MANUFACTURER [INA](#)

INTERCHANGE

ROLLWAY	AT-616
ANDREWS	RTWM-616