

RTWM-620 ANDREWS

Cylindrical roller thrust bearings

TYPE: Roller bearings, Thrust roller bearing, Cylindrical, Single direction, separable, cylindrical rollers, inch sizes, self-aligning

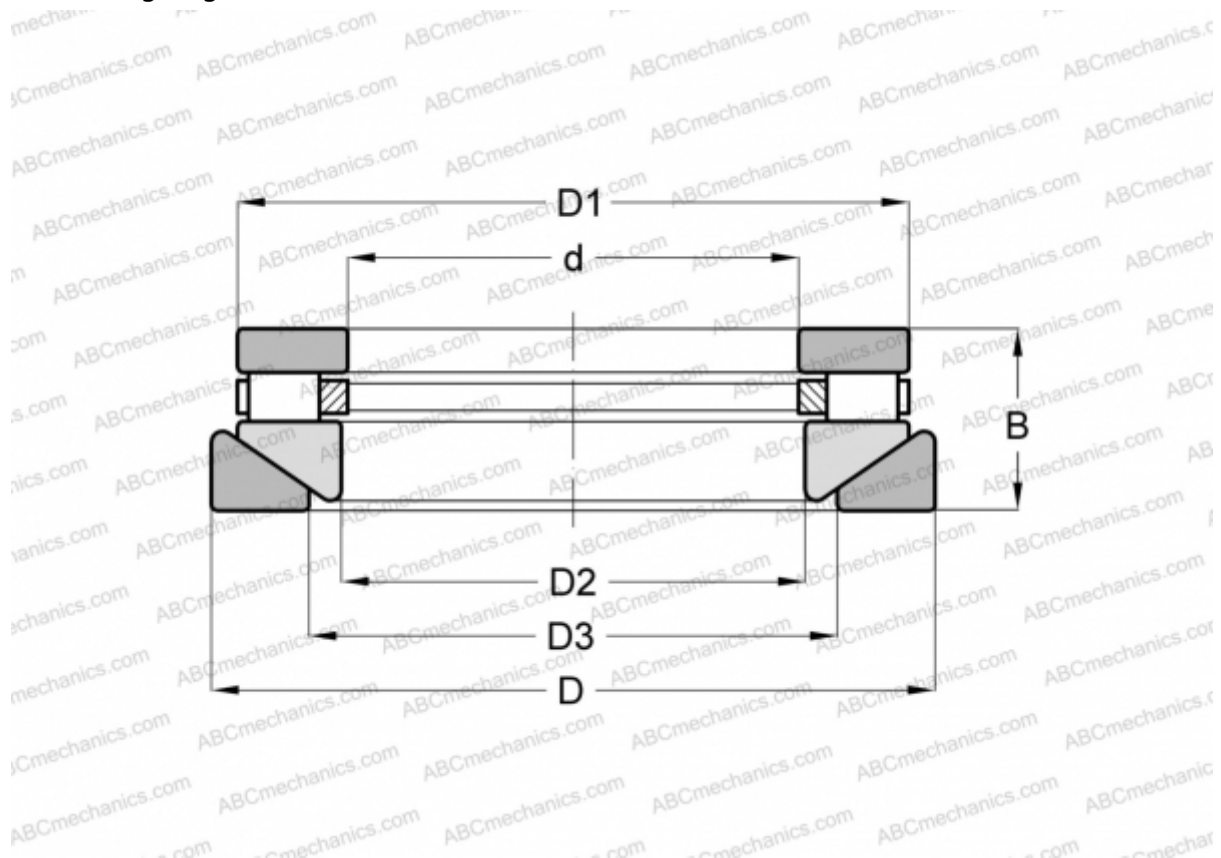

Technical specification

DIMENSIONS, MM

d	60,325
D	104,775
D1	99,218
D2	61,913
D3	73,025
B	33,338

WEIGHT, KG 1,179

MANUFACTURER [ANDREWS](#)

INTERCHANGE

ROLLWAY	AT-620
INA	RTW-620