

## RTW-620 INA

Cylindrical roller thrust bearings

TYPE: Roller bearings, Thrust roller bearing, Cylindrical, Single direction, separable, cylindrical rollers, inch sizes, self-aligning

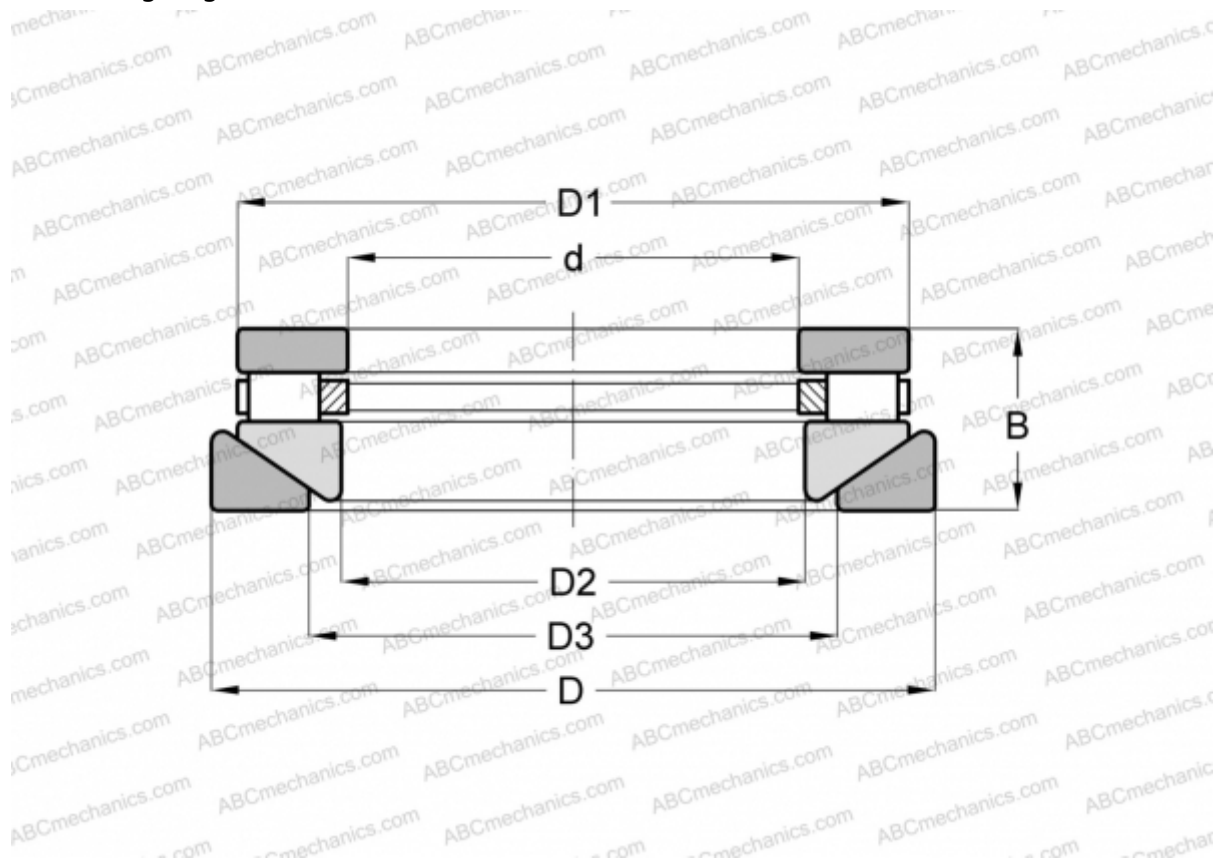

### Technical specification

#### DIMENSIONS, MM

d	60,325
D	104,775
D1	99,218
D2	61,913
D3	73,025
B	33,338

**WEIGHT, KG** 1,179

**MANUFACTURER** [INA](#)

#### INTERCHANGE

ROLLWAY	<a href="#">AT-620</a>
ANDREWS	<a href="#">RTWM-620</a>