

## AT-625 ROLLWAY

Cylindrical roller thrust bearings

TYPE: Roller bearings, Thrust roller bearing, Cylindrical, Single direction, separable, cylindrical rollers, inch sizes, self-aligning

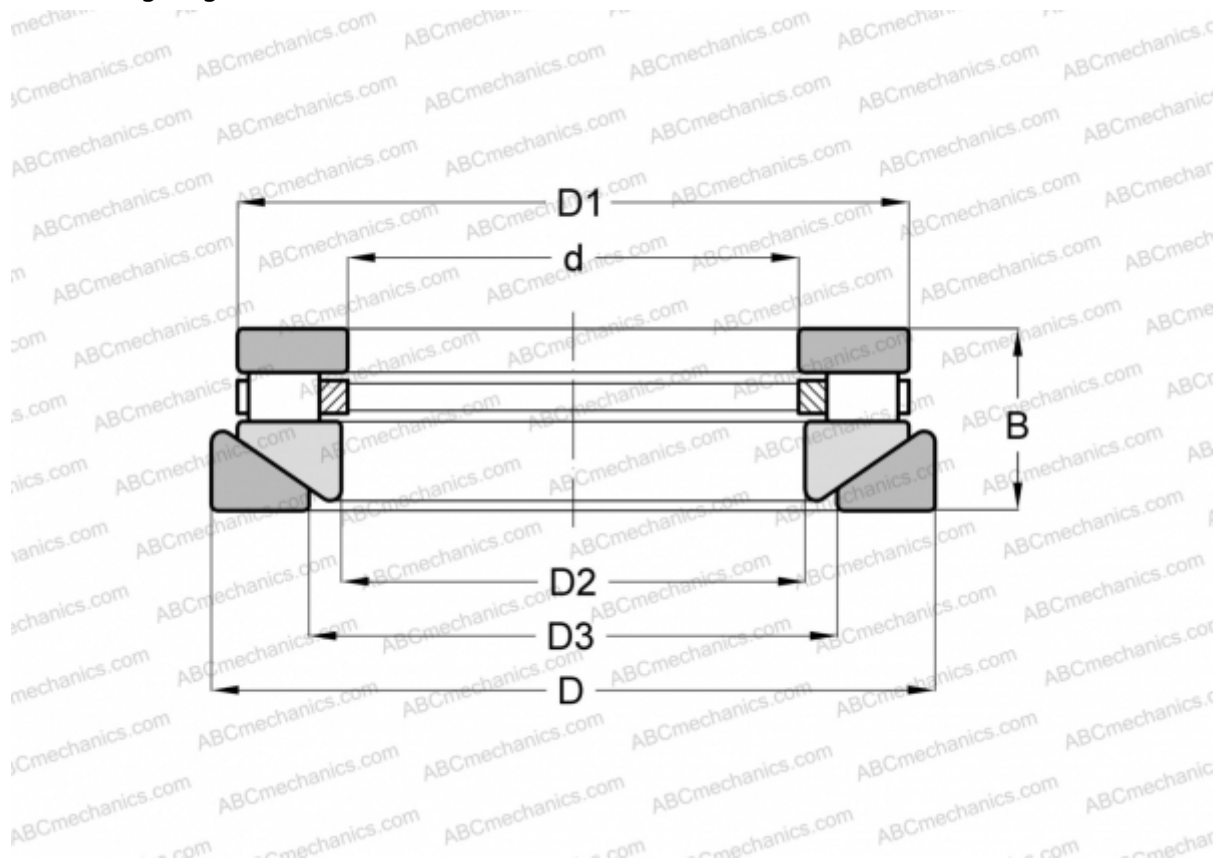

### Technical specification

#### DIMENSIONS, MM

d	82,550
D	132,555
D1	123,030
D2	84,930
D3	96,838
B	33,338

**WEIGHT, KG** 1,633

**MANUFACTURER** [ROLLWAY](#)

#### INTERCHANGE

ANDREWS	<a href="#">RTWM-625</a>
INA	<a href="#">RTW-625</a>