

20 TPS 104 TORRINGTON

Cylindrical roller thrust bearings

TYPE: Roller bearings, Thrust roller bearing, Cylindrical, Single direction, separable, cylindrical rollers, inch sizes, self-aligning

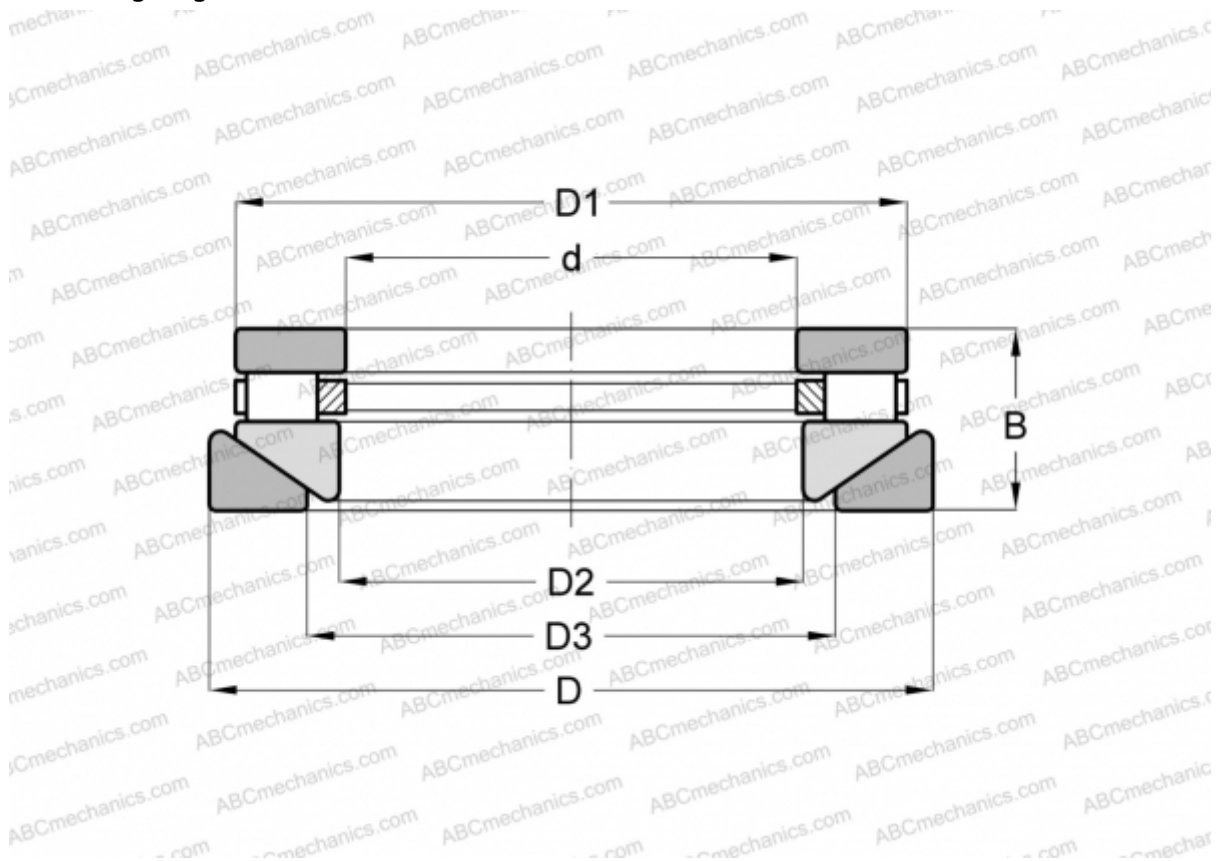

Technical specification

DIMENSIONS, MM

d	50,800
D	185,738
D1	176,212
D2	52,388
D3	107,950
B	46,038

WEIGHT, KG 7,167

MANUFACTURER [TORRINGTON](#)

INTERCHANGE

ROLLWAY	AT-728
ANDREWS	RTWH-728
INA	RTW-728