

RTWH-730 ANDREWS

Cylindrical roller thrust bearings

TYPE: Roller bearings, Thrust roller bearing, Cylindrical, Single direction, separable, cylindrical rollers, inch sizes, self-aligning

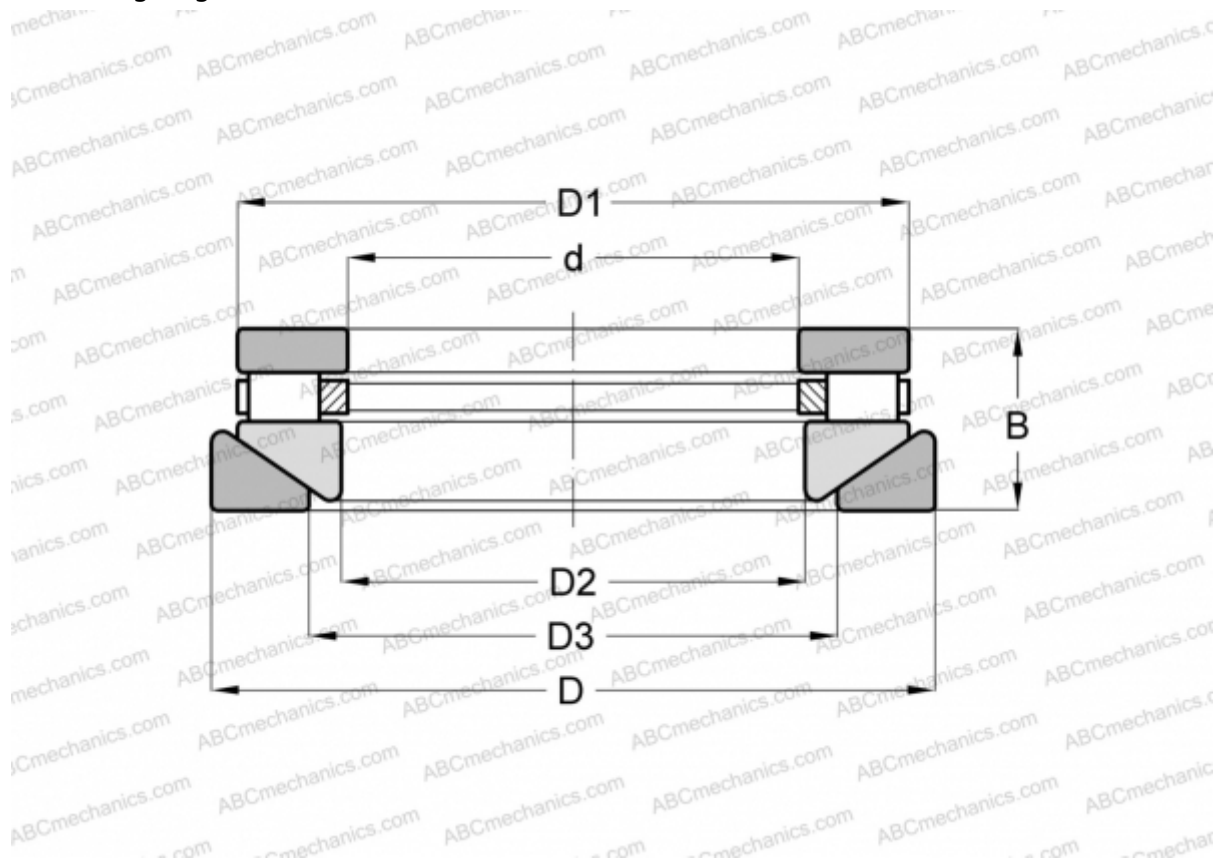

Technical specification

DIMENSIONS, MM

d	76,200
D	160,337
D1	150,812
D2	77,788
D3	101,600
B	46,038

WEIGHT, KG 4,354

MANUFACTURER [ANDREWS](#)

INTERCHANGE

ROLLWAY	AT-730
INA	RTW-730
TORRINGTON	30 TPS 106