

## RTW-730 INA

Cylindrical roller thrust bearings

TYPE: Roller bearings, Thrust roller bearing, Cylindrical, Single direction, separable, cylindrical rollers, inch sizes, self-aligning

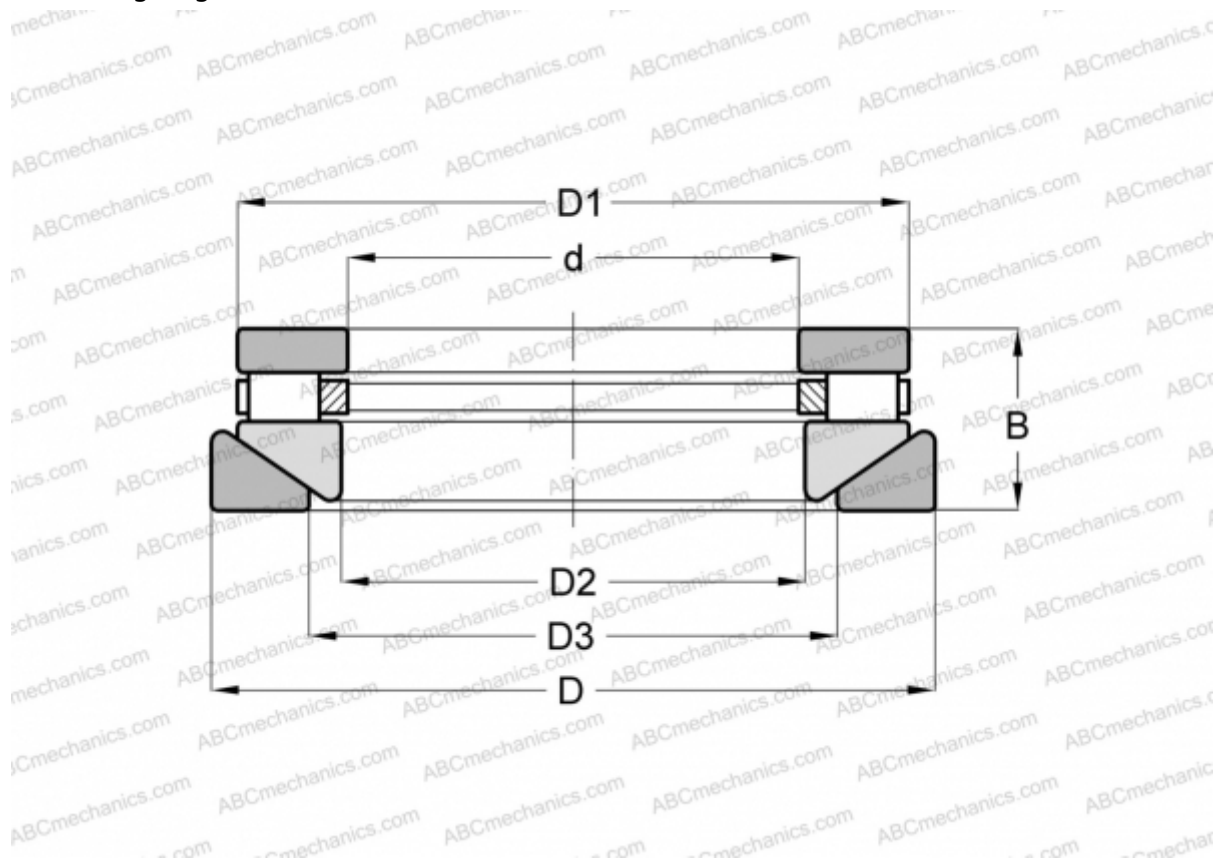

### Technical specification

#### DIMENSIONS, MM

d	76,200
D	160,337
D1	150,812
D2	77,788
D3	101,600
B	46,038

**WEIGHT, KG** 4,354

**MANUFACTURER** [INA](#)

#### INTERCHANGE

ROLLWAY	<a href="#">AT-730</a>
ANDREWS	<a href="#">RTWH-730</a>
TORRINGTON	<a href="#">30 TPS 106</a>