

## RTWH-731 ANDREWS

Cylindrical roller thrust bearings

TYPE: Roller bearings, Thrust roller bearing, Cylindrical, Single direction, separable, cylindrical rollers, inch sizes, self-aligning

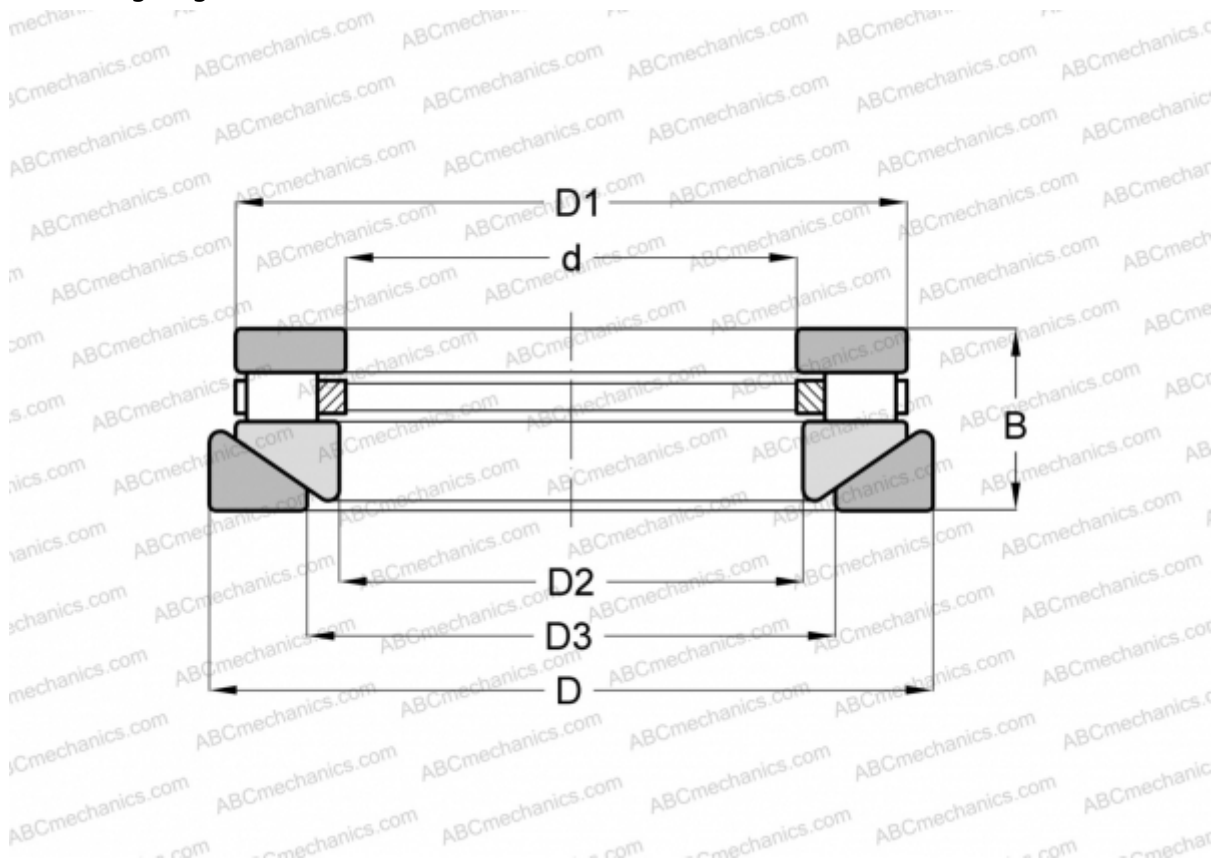

### Technical specification

#### DIMENSIONS, MM

d	76,200
D	185,738
D1	176,212
D2	77,788
D3	111,125
B	46,038

**WEIGHT, KG** 6,486

**MANUFACTURER** [ANDREWS](#)

#### INTERCHANGE

ROLLWAY	<a href="#">AT-731</a>
INA	<a href="#">RTW-731</a>
TORRINGTON	<a href="#">30 TPS 107</a>