

RTW-731 INA

Cylindrical roller thrust bearings

TYPE: Roller bearings, Thrust roller bearing, Cylindrical, Single direction, separable, cylindrical rollers, inch sizes, self-aligning

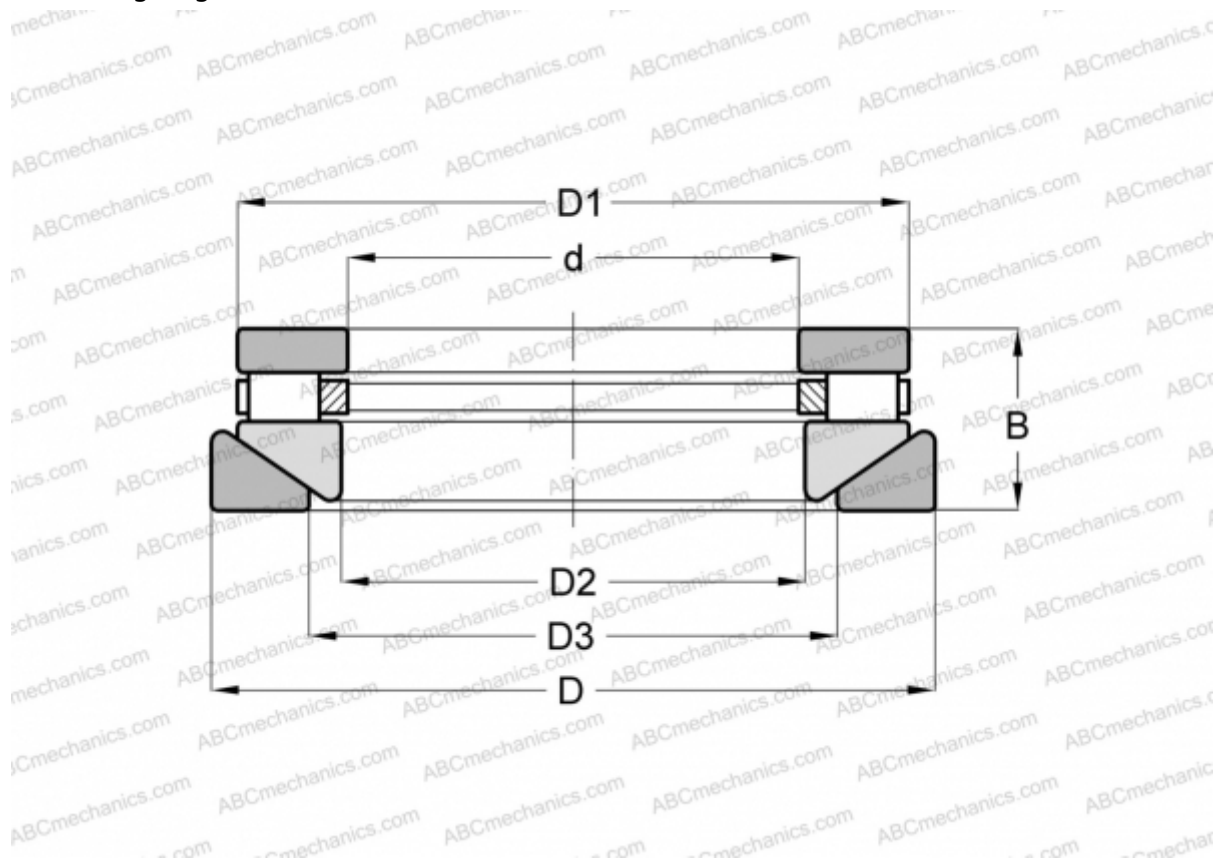

Technical specification

DIMENSIONS, MM

d	76,200
D	185,738
D1	176,212
D2	77,788
D3	111,125
B	46,038

WEIGHT, KG 6,486

MANUFACTURER [INA](#)

INTERCHANGE

ROLLWAY	AT-731
ANDREWS	RTWH-731
TORRINGTON	30 TPS 107