

## 40 TPS 115 TORRINGTON

Cylindrical roller thrust bearings

TYPE: Roller bearings, Thrust roller bearing, Cylindrical, Single direction, separable, cylindrical rollers, inch sizes, self-aligning

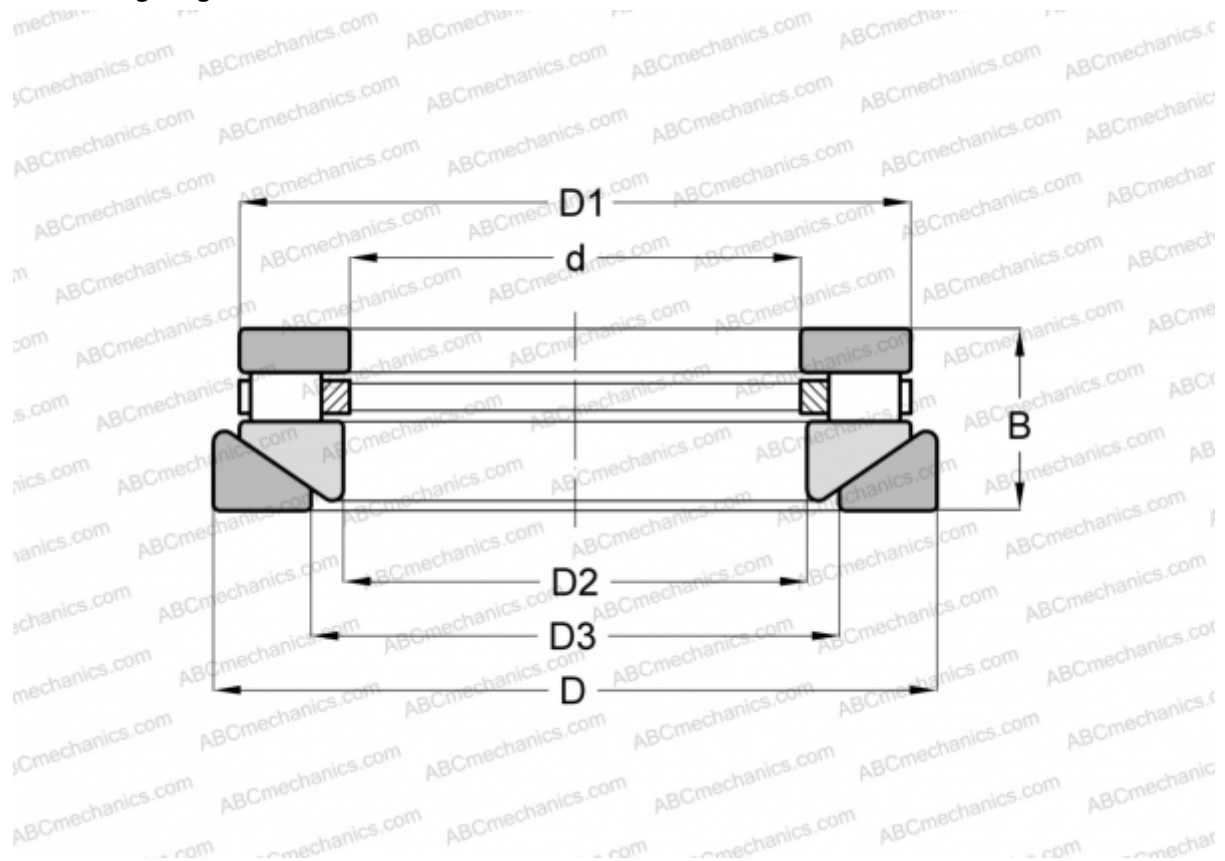

### Technical specification

#### DIMENSIONS, MM

d	101,600
D	212,725
D1	201,613
D2	103,980
D3	133,350
B	58,738

**WEIGHT, KG** 9,979

**MANUFACTURER** [TORRINGTON](#)

#### INTERCHANGE

ROLLWAY	<a href="#">AT-735</a>
ANDREWS	<a href="#">RTWH-735</a>
INA	<a href="#">RTW-735</a>