

## RTWH-737 ANDREWS

Cylindrical roller thrust bearings

TYPE: Roller bearings, Thrust roller bearing, Cylindrical, Single direction, separable, cylindrical rollers, inch sizes, self-aligning

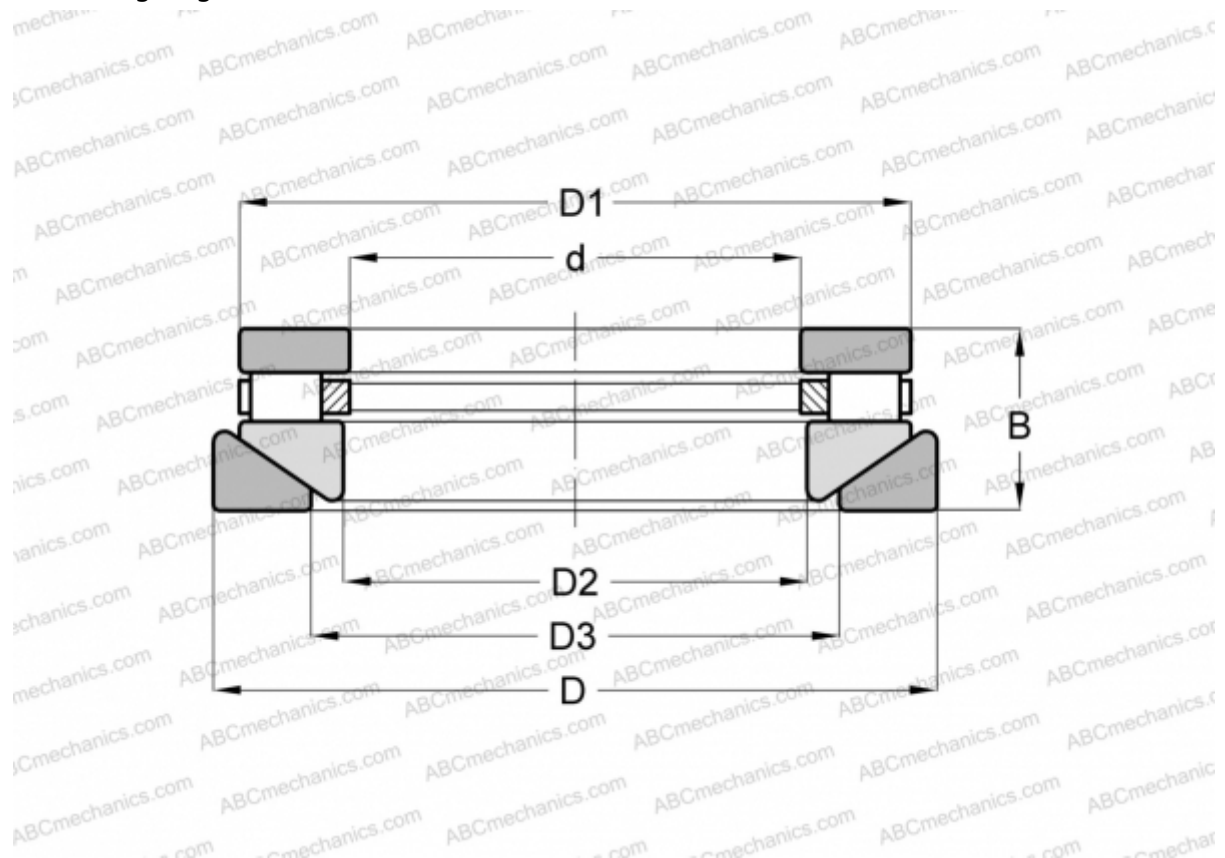

### Technical specification

#### DIMENSIONS, MM

d	101,600
D	266,700
D1	252,413
D2	103,980
D3	165,100
B	58,738

**WEIGHT, KG** 17,690

**MANUFACTURER** [ANDREWS](#)

#### INTERCHANGE

ROLLWAY	<a href="#">AT-737</a>
INA	<a href="#">RTW-737</a>
TORRINGTON	<a href="#">40 TPS 117</a>