

RTWH-738 ANDREWS

Cylindrical roller thrust bearings

TYPE: Roller bearings, Thrust roller bearing, Cylindrical, Single direction, separable, cylindrical rollers, inch sizes, self-aligning

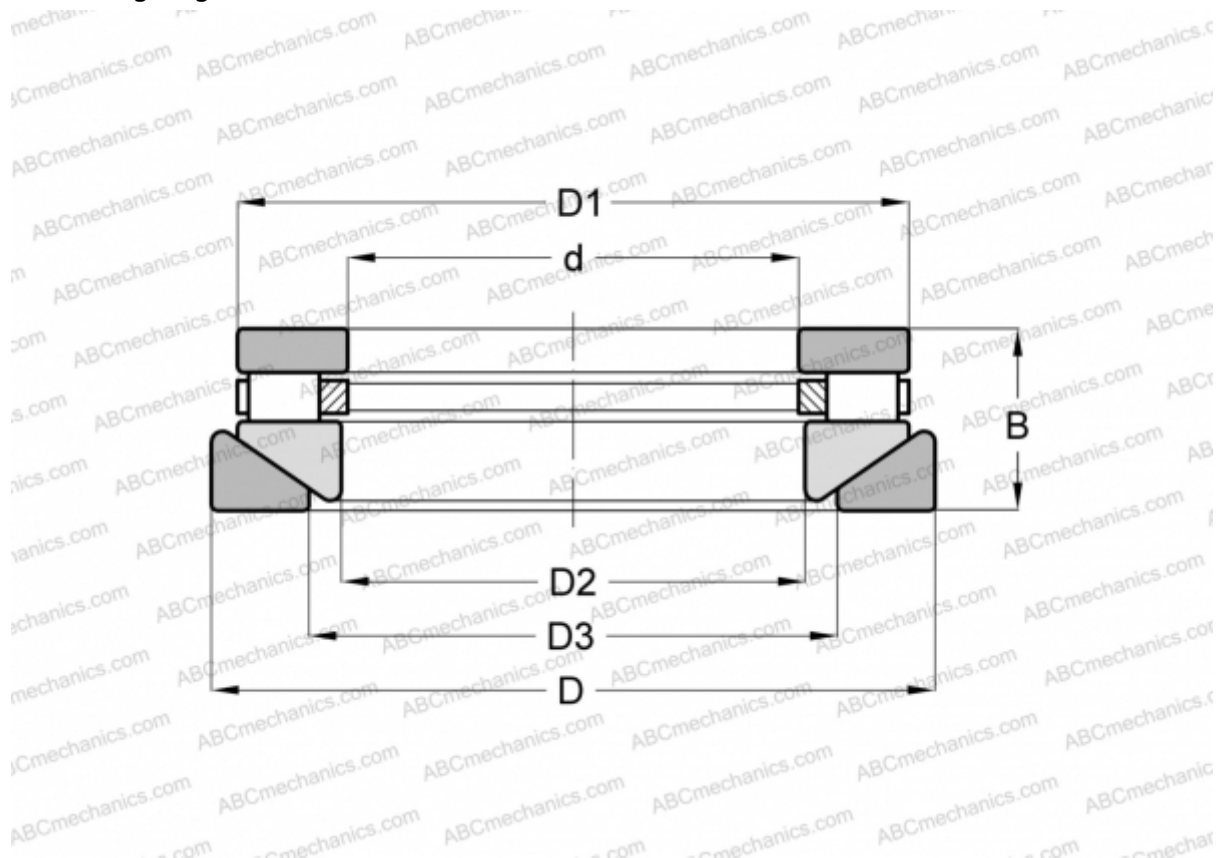

Technical specification

DIMENSIONS, MM

d	127,000
D	215,900
D1	201,613
D2	130,175
D3	152,400
B	58,738

WEIGHT, KG 8,165

MANUFACTURER [ANDREWS](#)

INTERCHANGE

ROLLWAY	AT-738
INA	RTW-738
TORRINGTON	50 TPS 119