

RTW-739 INA

Cylindrical roller thrust bearings

TYPE: Roller bearings, Thrust roller bearing, Cylindrical, Single direction, separable, cylindrical rollers, inch sizes, self-aligning

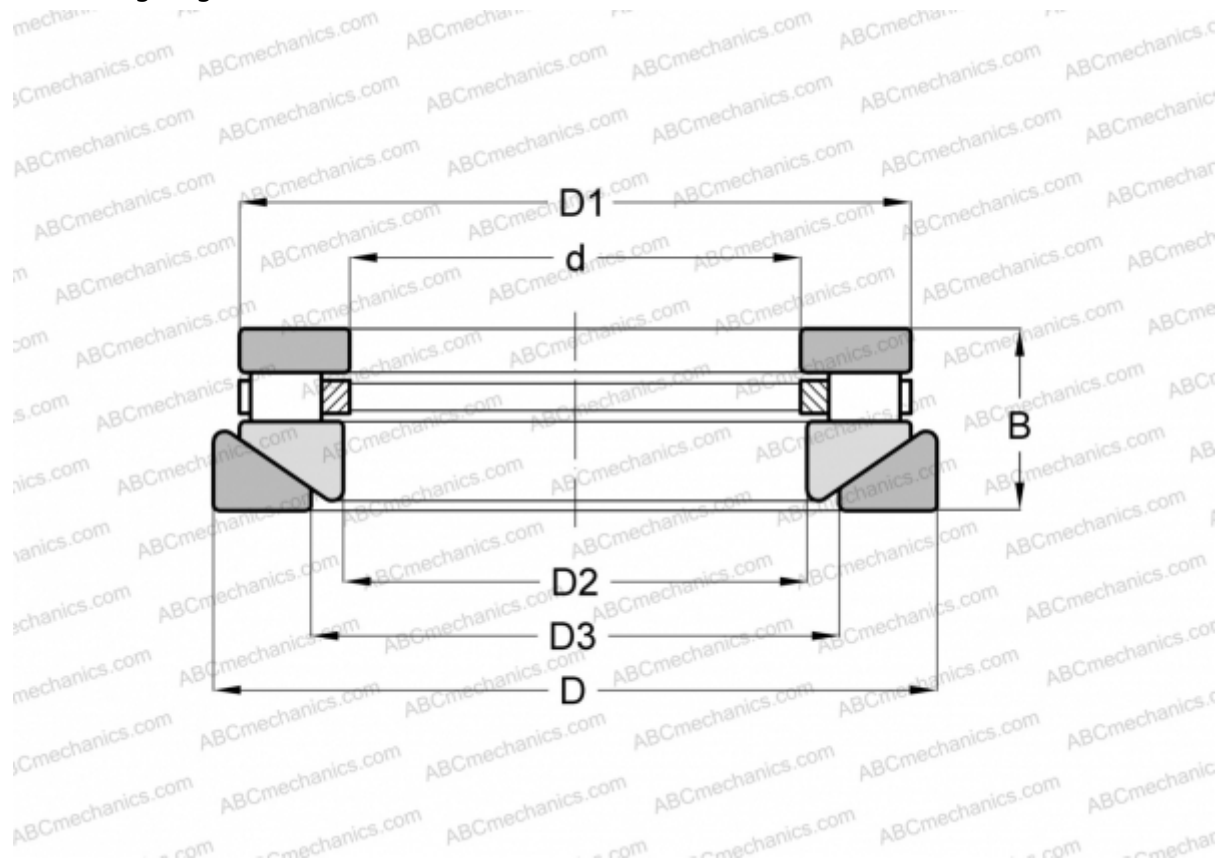

Technical specification

DIMENSIONS, MM

d	127,000
D	241,300
D1	227,012
D2	130,175
D3	155,575
B	58,738

WEIGHT, KG 11,793

MANUFACTURER [INA](#)

INTERCHANGE

ROLLWAY	AT-739
ANDREWS	RTWH-739
TORRINGTON	50 TPS 120