

RTW-740 INA

Cylindrical roller thrust bearings

TYPE: Roller bearings, Thrust roller bearing, Cylindrical, Single direction, separable, cylindrical rollers, inch sizes, self-aligning

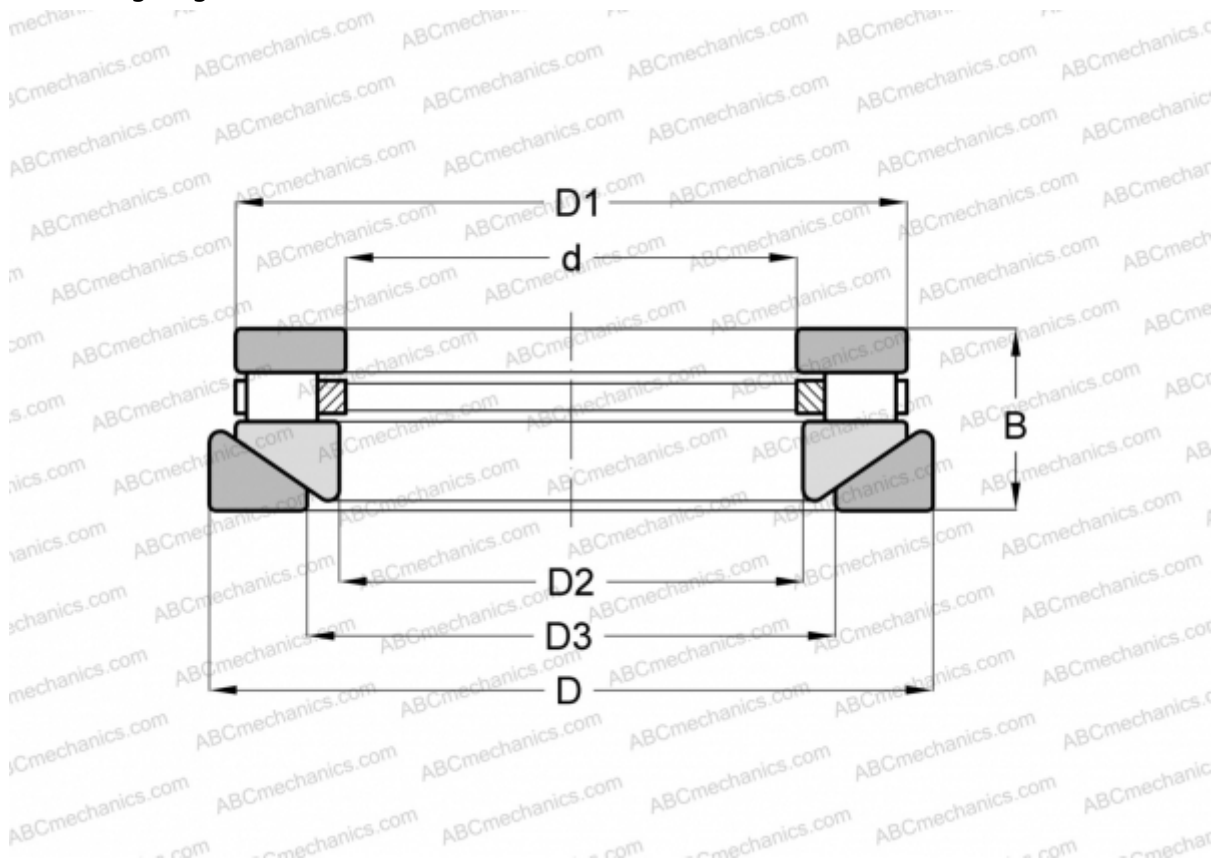

Technical specification

DIMENSIONS, MM

d	127,000
D	266,700
D1	252,413
D2	130,175
D3	158,750
B	66,675

WEIGHT, KG 17,690

MANUFACTURER [INA](#)

INTERCHANGE

ROLLWAY	AT-740
ANDREWS	RTWH-740
TORRINGTON	50 TPS 121