

RTWH-741 ANDREWS

Cylindrical roller thrust bearings

TYPE: Roller bearings, Thrust roller bearing, Cylindrical, Single direction, separable, cylindrical rollers, inch sizes, self-aligning

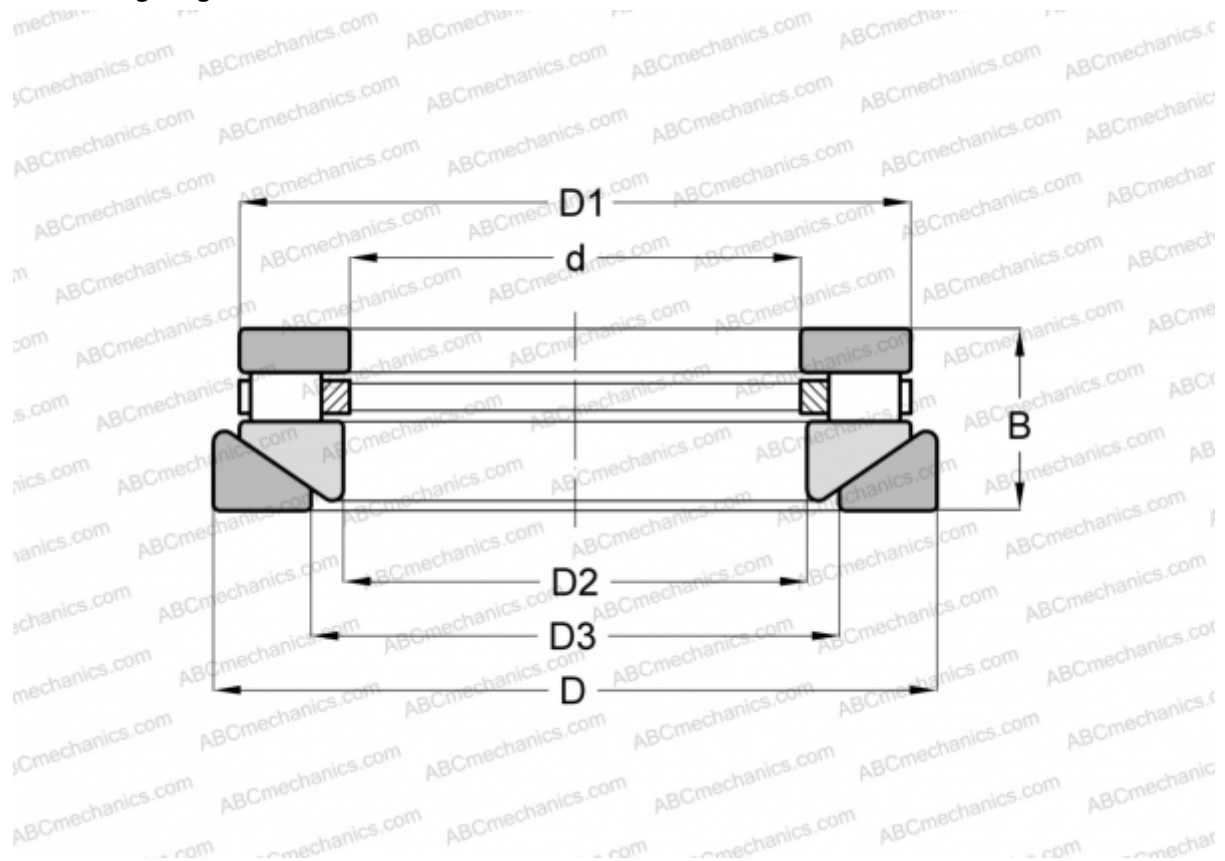

Technical specification

DIMENSIONS, MM

d	127,000
D	292,100
D1	277,812
D2	130,175
D3	177,800
B	66,675

WEIGHT, KG 22,680

MANUFACTURER [ANDREWS](#)

INTERCHANGE

ROLLWAY	AT-741
INA	RTW-741
TORRINGTON	50 TPS 122