

RTW-742 INA

Cylindrical roller thrust bearings

TYPE: Roller bearings, Thrust roller bearing, Cylindrical, Single direction, separable, cylindrical rollers, inch sizes, self-aligning

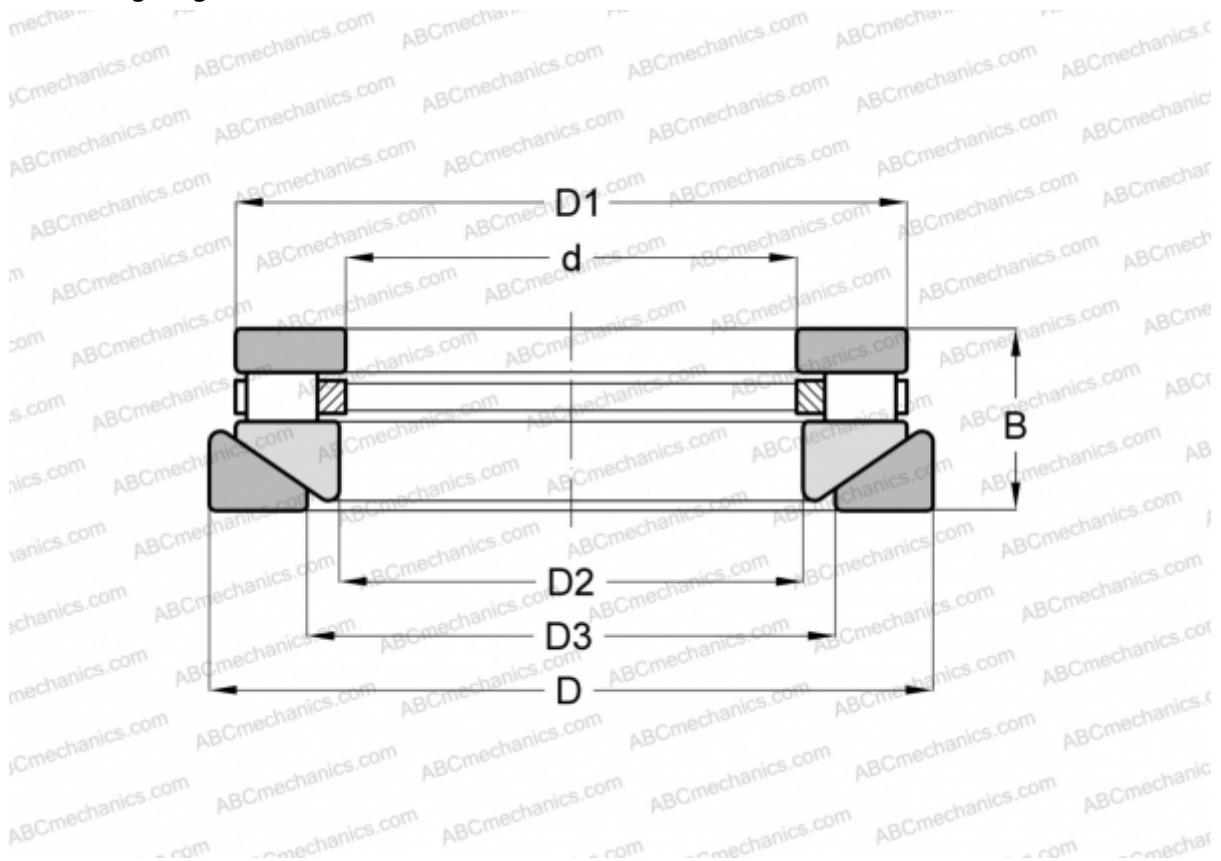

Technical specification

DIMENSIONS, MM

d	127,000
D	317,500
D1	303,212
D2	130,175
D3	184,150
B	66,675

WEIGHT, KG 28,576

MANUFACTURER [INA](#)

INTERCHANGE

ROLLWAY	AT-742
ANDREWS	RTWH-742
TORRINGTON	50 TPS 123