

## RTWH-744 ANDREWS

Cylindrical roller thrust bearings

TYPE: Roller bearings, Thrust roller bearing, Cylindrical, Single direction, separable, cylindrical rollers, inch sizes, self-aligning

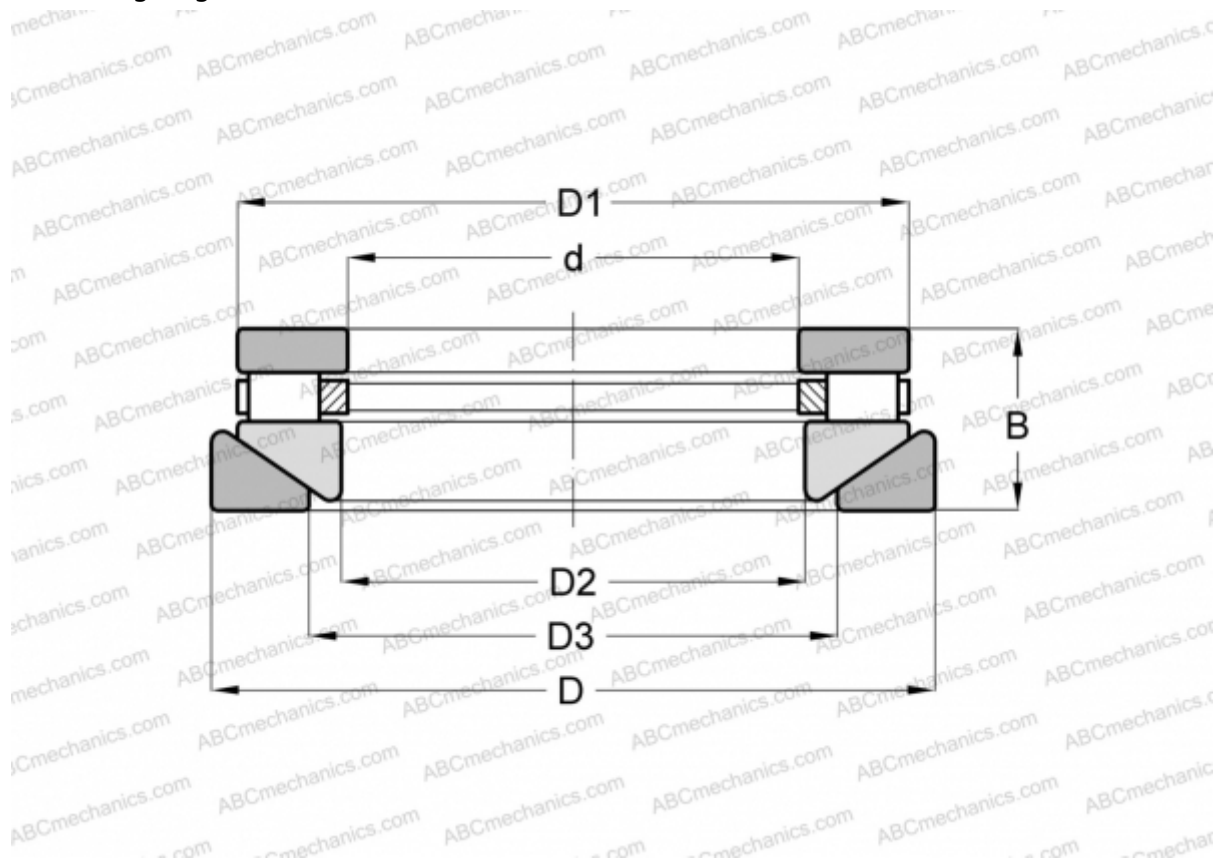

### Technical specification

#### DIMENSIONS, MM

d	152,400
D	266,700
D1	252,413
D2	155,575
D3	187,325
B	66,675

**WEIGHT, KG** 14,969

**MANUFACTURER** [ANDREWS](#)

#### INTERCHANGE

ROLLWAY	<a href="#">AT-744</a>
INA	<a href="#">RTW-744</a>
TORRINGTON	<a href="#">60 TPS 125</a>