

RTW-744 INA

Cylindrical roller thrust bearings

TYPE: Roller bearings, Thrust roller bearing, Cylindrical, Single direction, separable, cylindrical rollers, inch sizes, self-aligning

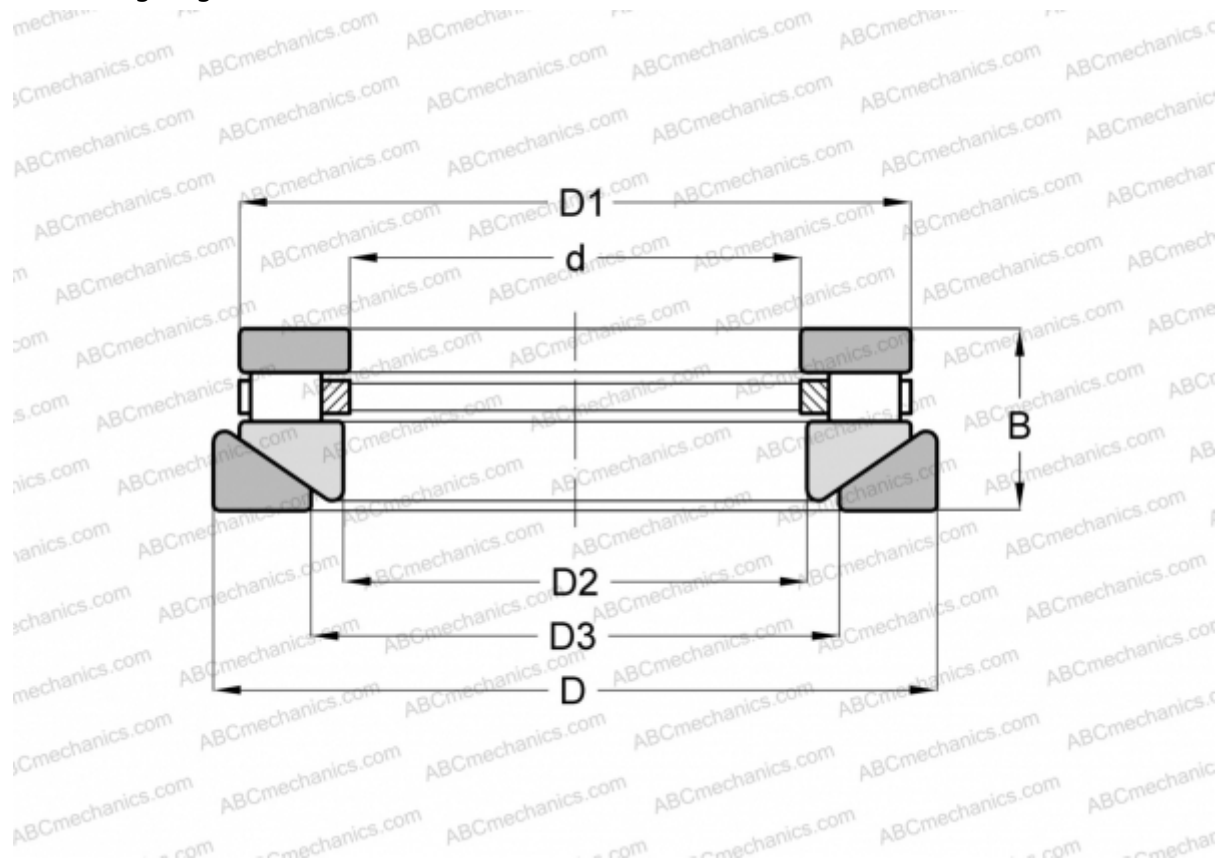

Technical specification

DIMENSIONS, MM

d	152,400
D	266,700
D1	252,413
D2	155,575
D3	187,325
B	66,675

WEIGHT, KG 14,969

MANUFACTURER [INA](#)

INTERCHANGE

ROLLWAY	AT-744
ANDREWS	RTWH-744
TORRINGTON	60 TPS 125