

AT-745 ROLLWAY

Cylindrical roller thrust bearings

TYPE: Roller bearings, Thrust roller bearing, Cylindrical, Single direction, separable, cylindrical rollers, inch sizes, self-aligning

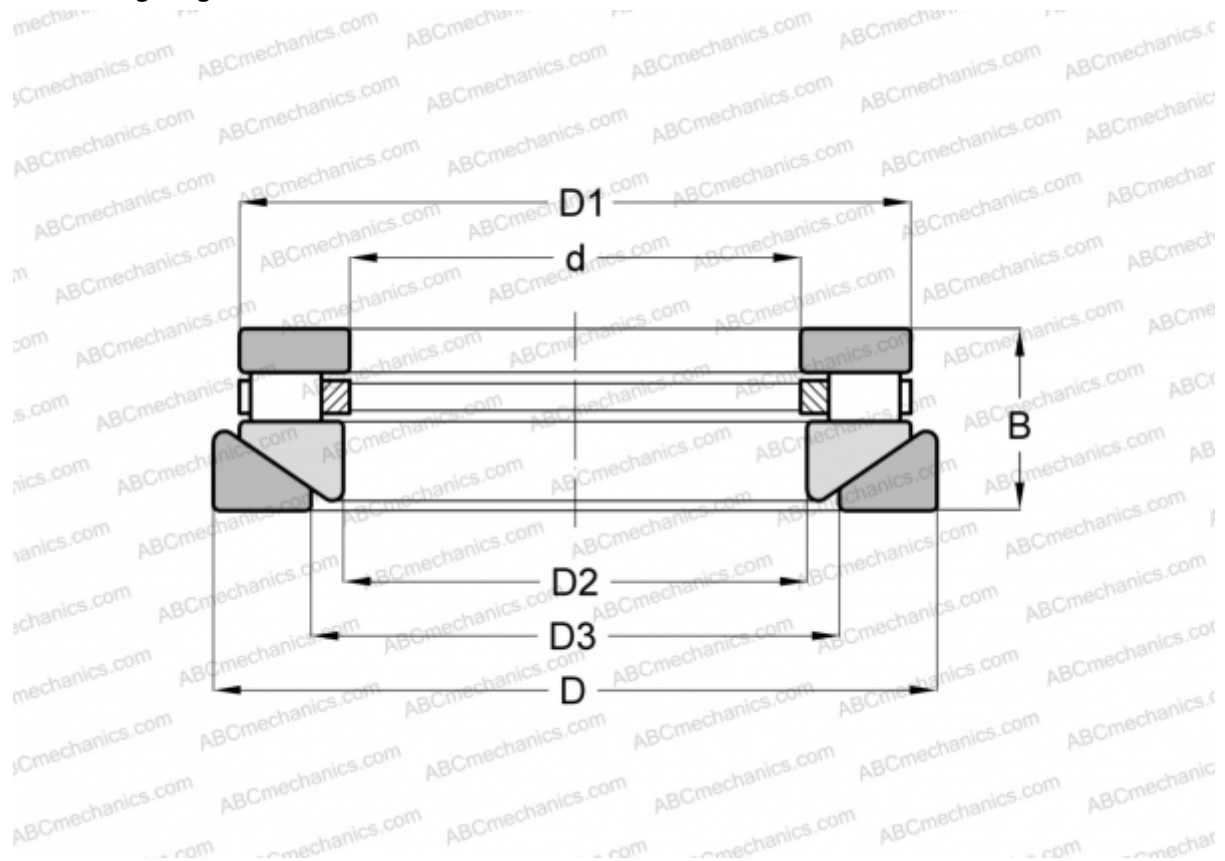

Technical specification

DIMENSIONS, MM

d	152,400
D	292,100
D1	277,812
D2	155,575
D3	187,325
B	66,675

WEIGHT, KG 19,958

MANUFACTURER [ROLLWAY](#)

INTERCHANGE

ANDREWS	RTWH-745
INA	RTW-745
TORRINGTON	60 TPS 126