

60 TPS 127 TORRINGTON

Cylindrical roller thrust bearings

TYPE: Roller bearings, Thrust roller bearing, Cylindrical, Single direction, separable, cylindrical rollers, inch sizes, self-aligning

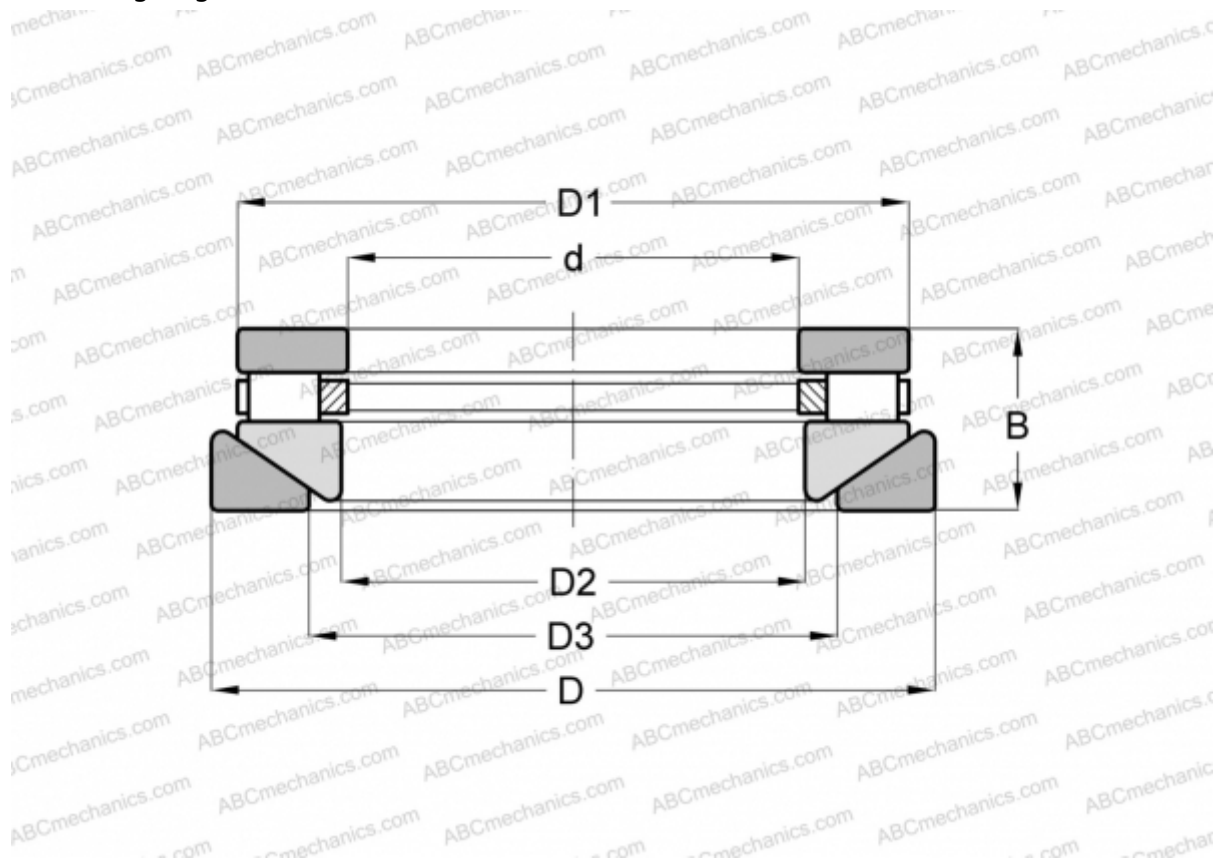

Technical specification

DIMENSIONS, MM

d	152,400
D	317,500
D1	303,212
D2	155,575
D3	190,500
B	66,675

WEIGHT, KG 25,855

MANUFACTURER [TORRINGTON](#)

INTERCHANGE

ROLLWAY	AT-746
ANDREWS	RTWH-746
INA	RTW-746