

## AT-747 ROLLWAY

Cylindrical roller thrust bearings

TYPE: Roller bearings, Thrust roller bearing, Cylindrical, Single direction, separable, cylindrical rollers, inch sizes, self-aligning

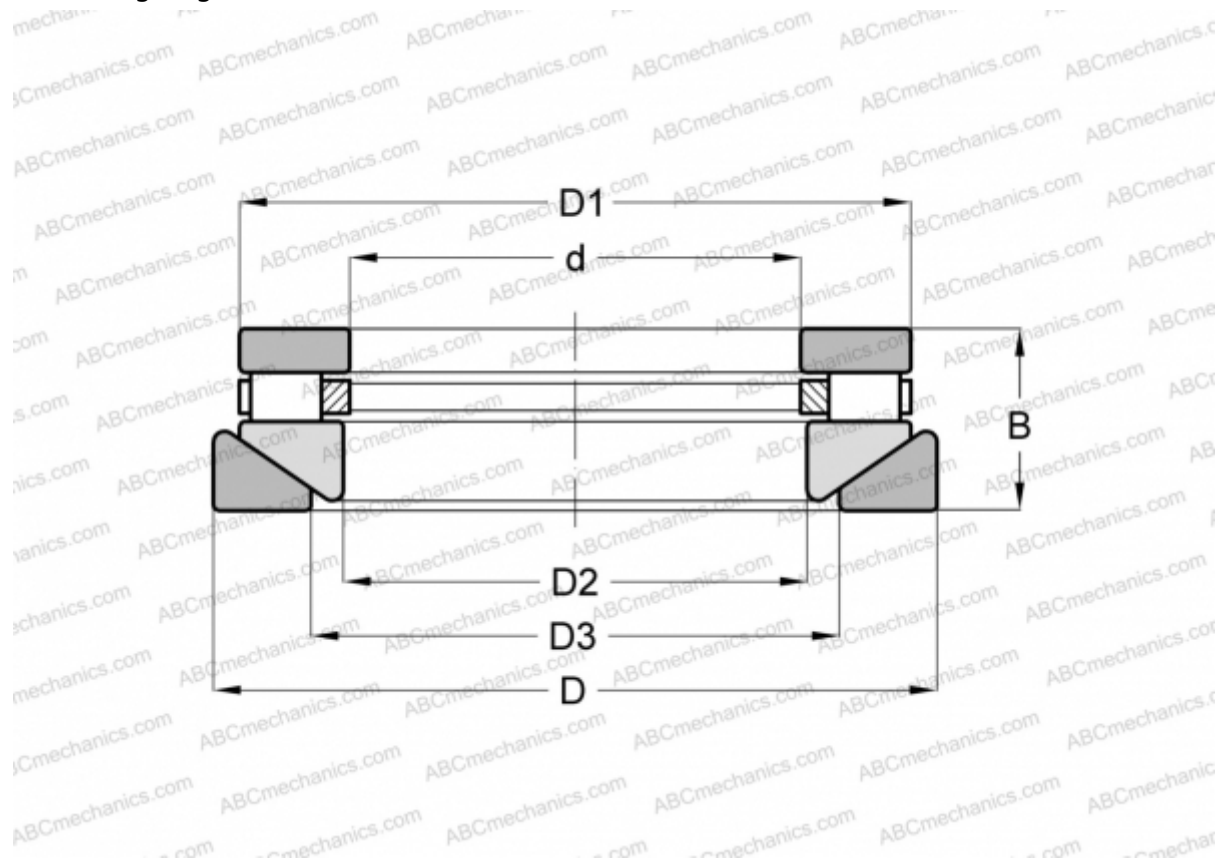

### Technical specification

#### DIMENSIONS, MM

d	177,800
D	266,700
D1	251,638
D2	180,975
D3	206,375
B	66,675

**WEIGHT, KG** 11,793

**MANUFACTURER** [ROLLWAY](#)

#### INTERCHANGE

ANDREWS	<a href="#">RTWH-747</a>
INA	<a href="#">RTW-747</a>
TORRINGTON	<a href="#">70 TPS 129</a>