

RTW-747 INA

Cylindrical roller thrust bearings

TYPE: Roller bearings, Thrust roller bearing, Cylindrical, Single direction, separable, cylindrical rollers, inch sizes, self-aligning

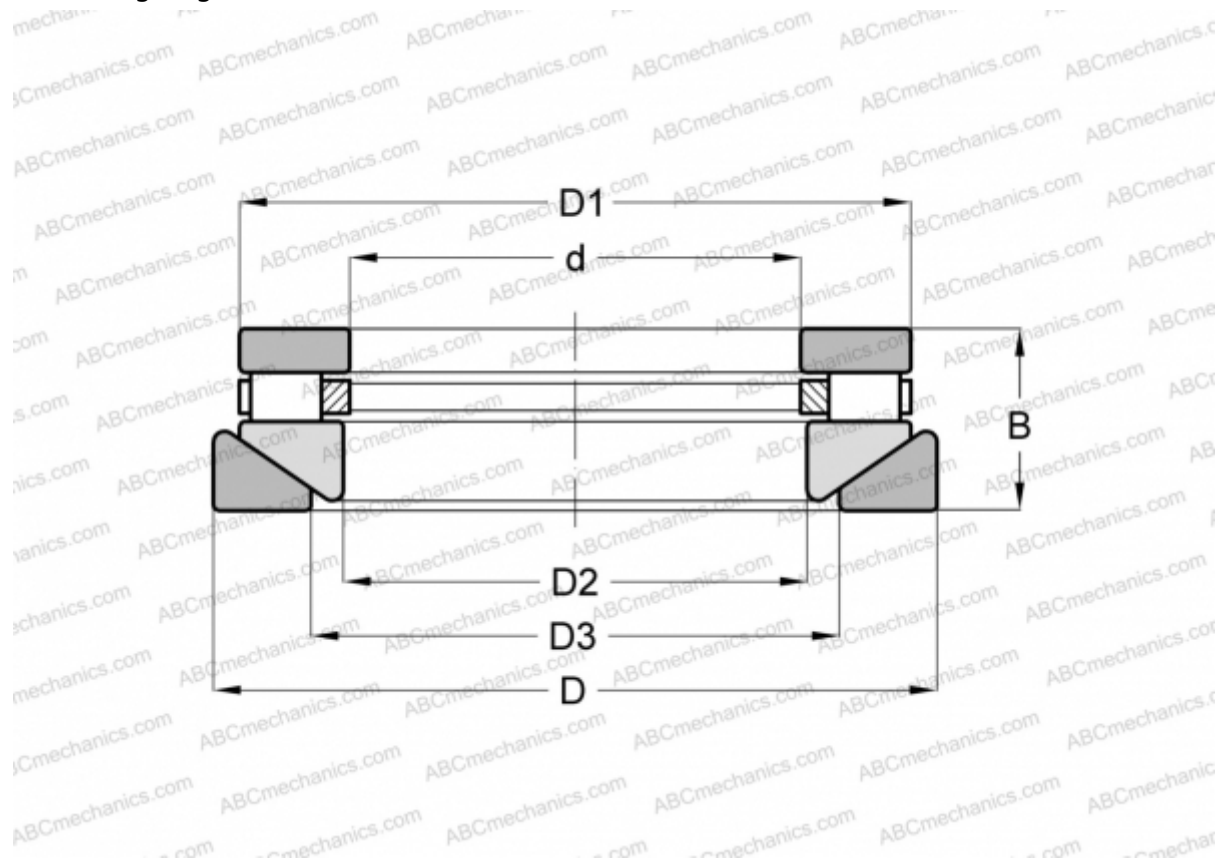

Technical specification

DIMENSIONS, MM

d	177,800
D	266,700
D1	251,638
D2	180,975
D3	206,375
B	66,675

WEIGHT, KG 11,793

MANUFACTURER [INA](#)

INTERCHANGE

ROLLWAY	AT-747
ANDREWS	RTWH-747
TORRINGTON	70 TPS 129