

AT-748 ROLLWAY

Cylindrical roller thrust bearings

TYPE: Roller bearings, Thrust roller bearing, Cylindrical, Single direction, separable, cylindrical rollers, inch sizes, self-aligning

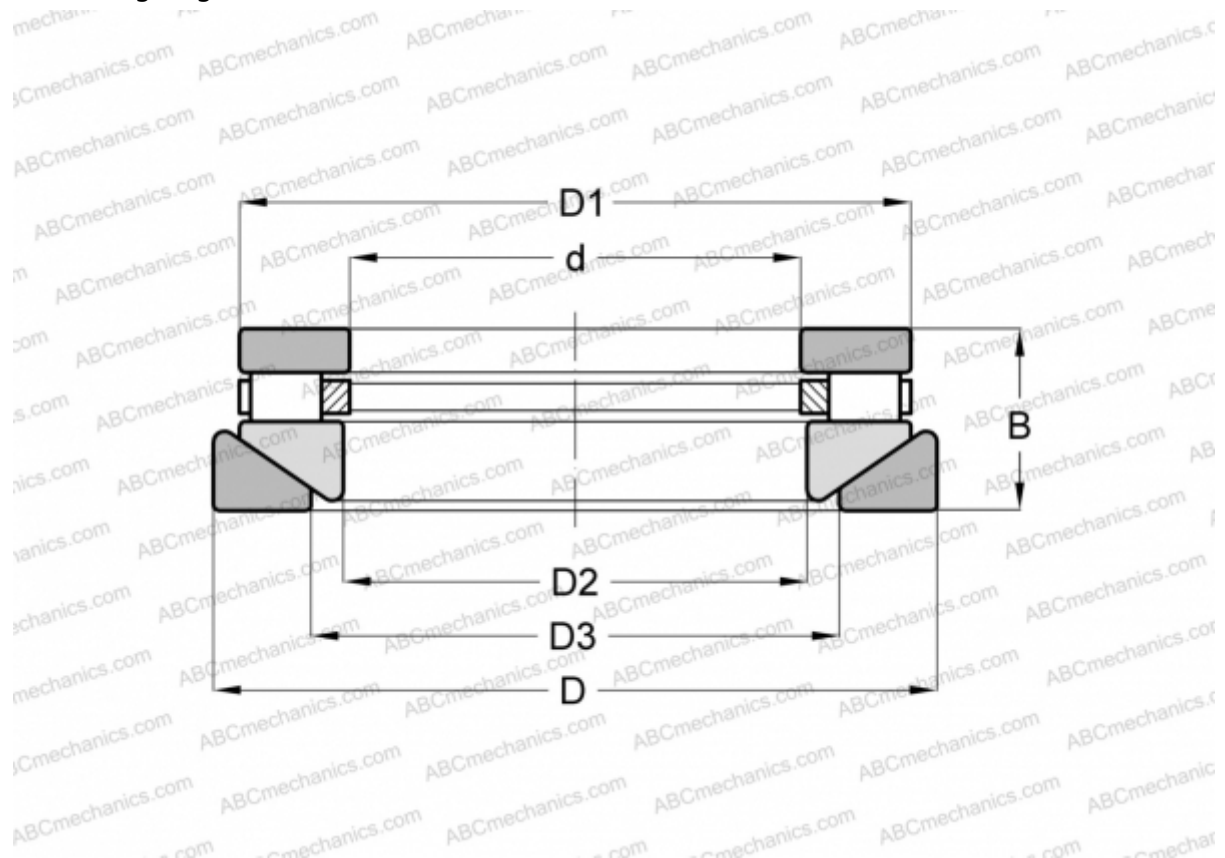

Technical specification

DIMENSIONS, MM

d	177,800
D	292,100
D1	277,038
D2	180,975
D3	209,550
B	66,675

WEIGHT, KG 16,783

MANUFACTURER [ROLLWAY](#)

INTERCHANGE

ANDREWS	RTWH-748
INA	RTW-748
TORRINGTON	70 TPS 130