

RTW-749 INA

Cylindrical roller thrust bearings

TYPE: Roller bearings, Thrust roller bearing, Cylindrical, Single direction, separable, cylindrical rollers, inch sizes, self-aligning

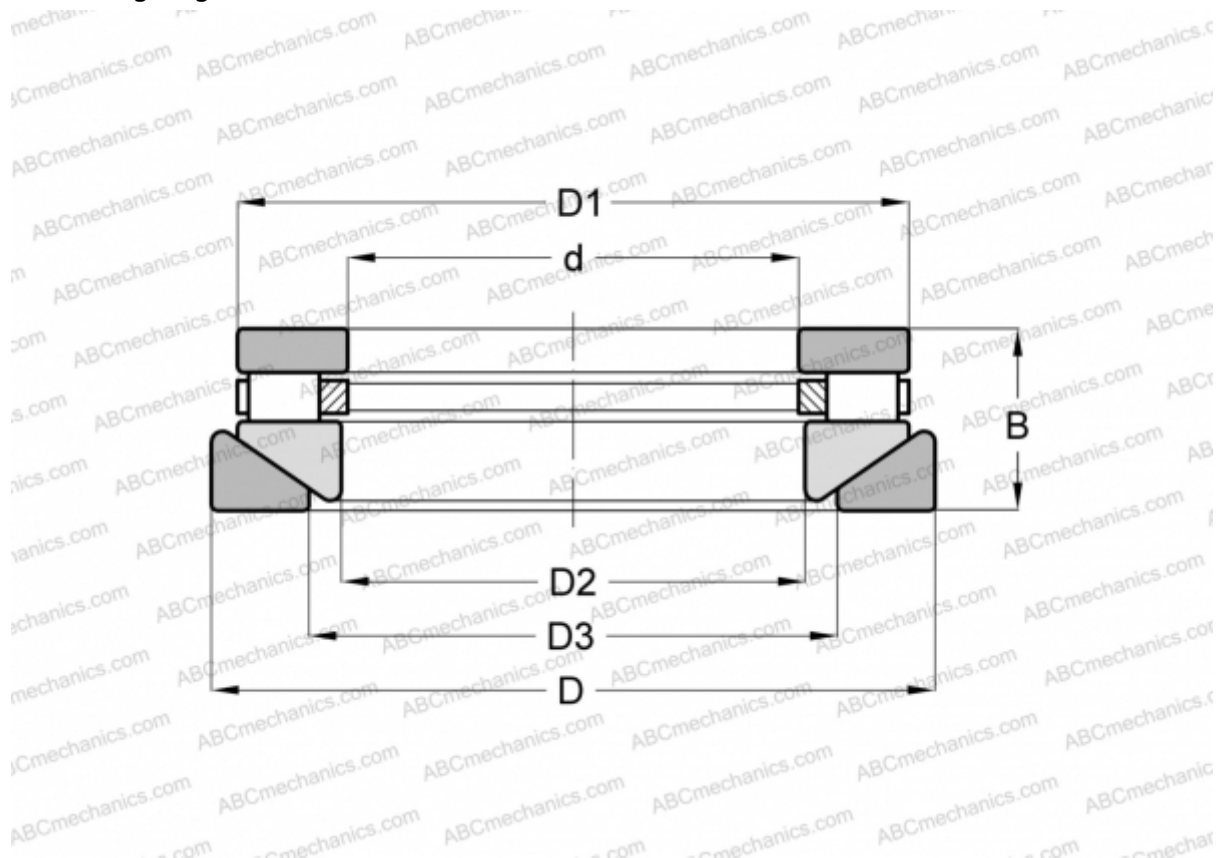

Technical specification

DIMENSIONS, MM

d	177,800
D	317,500
D1	302,438
D2	180,975
D3	209,550
B	66,675

WEIGHT, KG 22,680

MANUFACTURER [INA](#)

INTERCHANGE

ROLLWAY	AT-749
ANDREWS	RTWH-749
TORRINGTON	70 TPS 131