

RTW-751 INA

Cylindrical roller thrust bearings

TYPE: Roller bearings, Thrust roller bearing, Cylindrical, Single direction, separable, cylindrical rollers, inch sizes, self-aligning

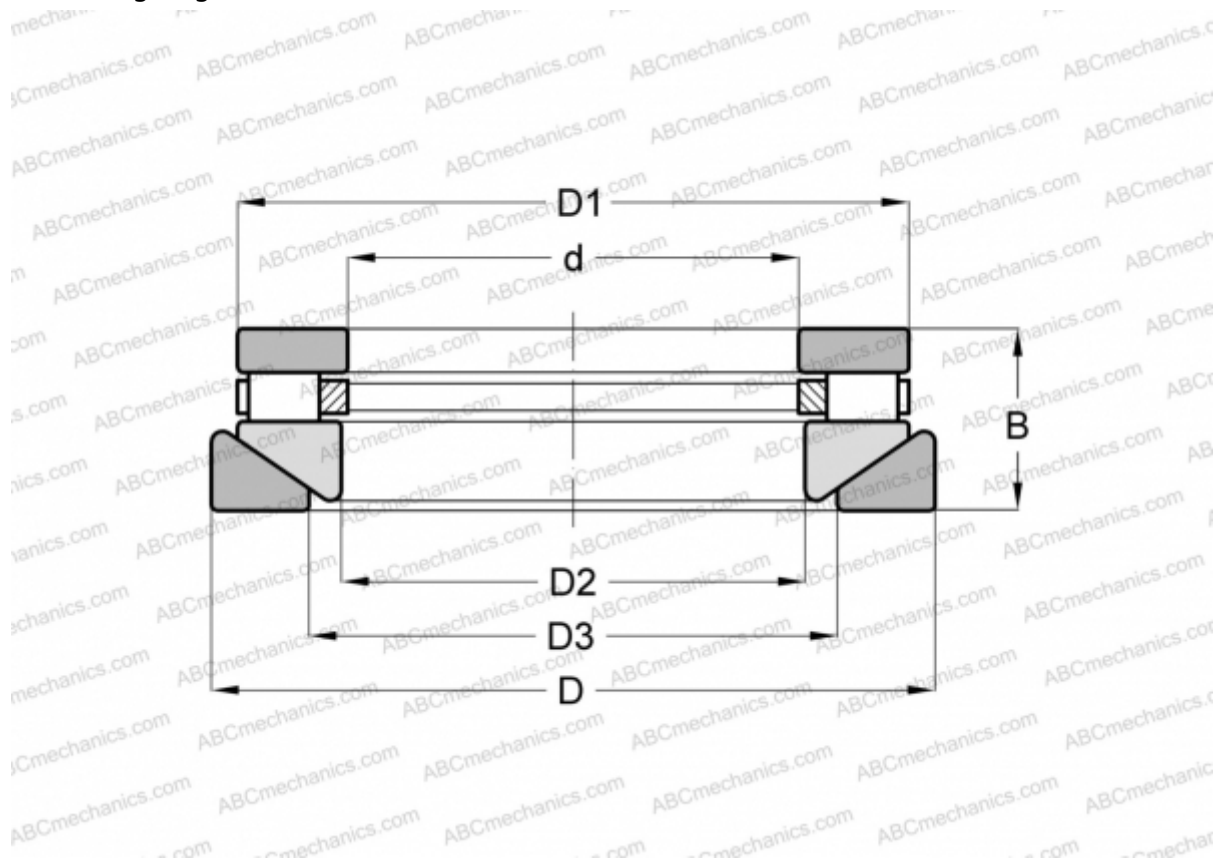

Technical specification

DIMENSIONS, MM

d	203,200
D	323,850
D1	302,438
D2	207,962
D3	238,125
B	101,600

WEIGHT, KG 28,576

MANUFACTURER [INA](#)

INTERCHANGE

ROLLWAY	AT-751
ANDREWS	RTWH-751
TORRINGTON	80 TPS 134