

RTW-752 INA

Cylindrical roller thrust bearings

TYPE: Roller bearings, Thrust roller bearing, Cylindrical, Single direction, separable, cylindrical rollers, inch sizes, self-aligning

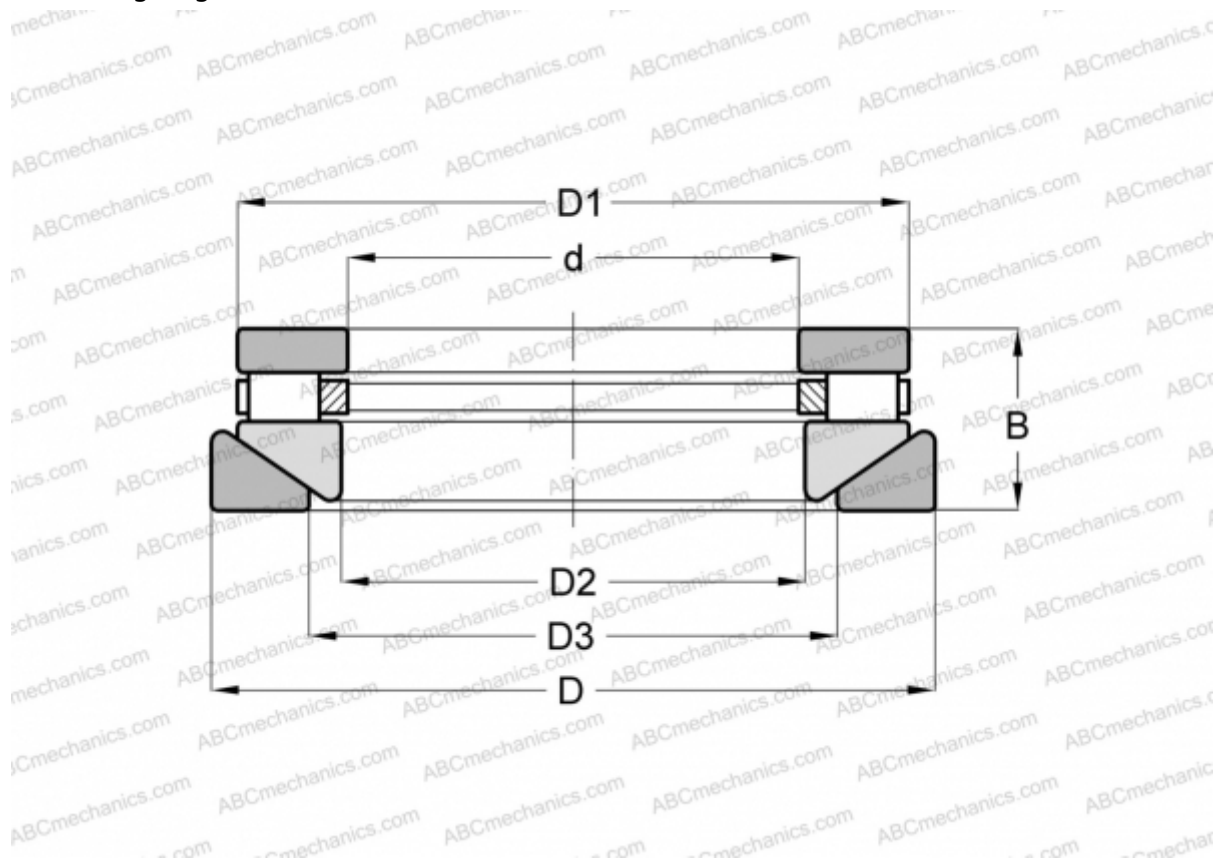

Technical specification

DIMENSIONS, MM

d	203,200
D	374,650
D1	353,238
D2	207,962
D3	263,525
B	101,600

WEIGHT, KG 48,534

MANUFACTURER [INA](#)

INTERCHANGE

ROLLWAY	AT-752
ANDREWS	RTWH-752
TORRINGTON	80 TPS 135