

80 TPS 136 TORRINGTON

Cylindrical roller thrust bearings

TYPE: Roller bearings, Thrust roller bearing, Cylindrical, Single direction, separable, cylindrical rollers, inch sizes, self-aligning

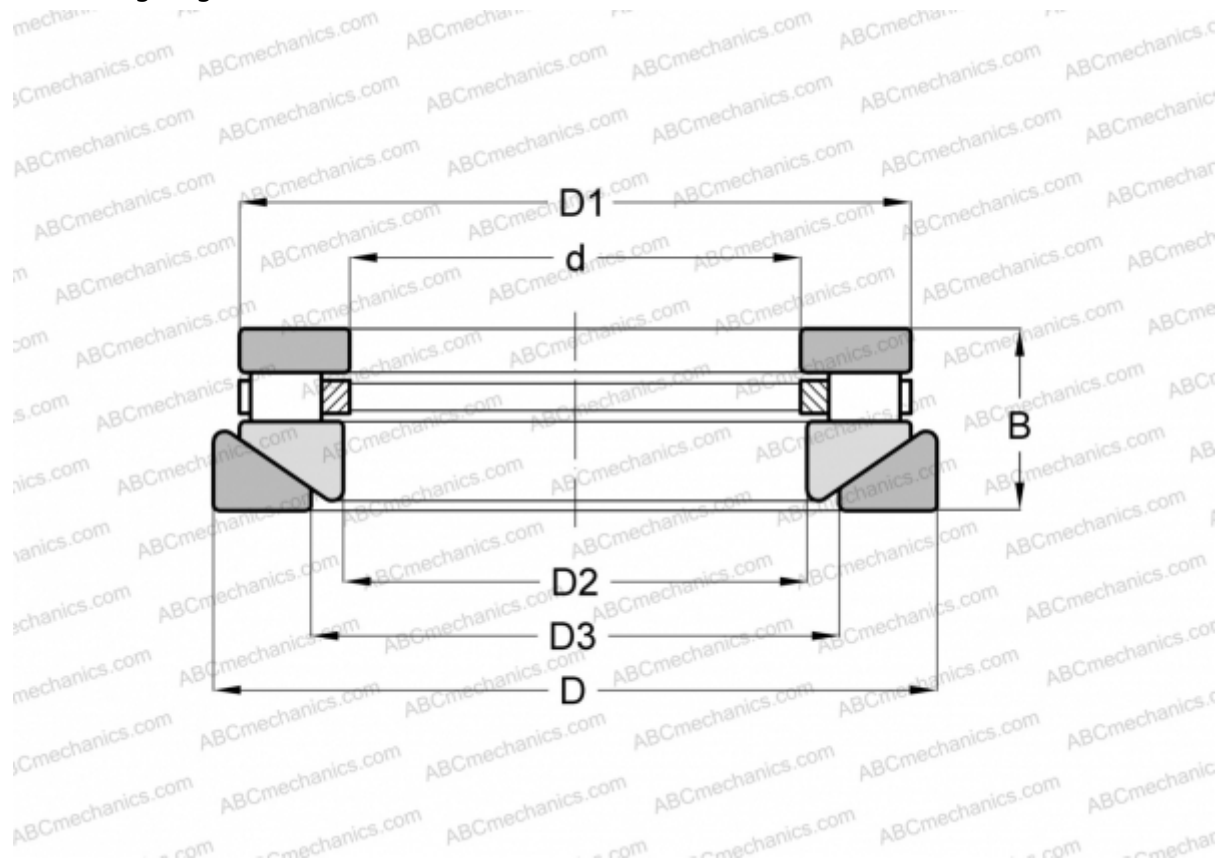

Technical specification

DIMENSIONS, MM

d	203,200
D	428,625
D1	404,038
D2	209,550
D3	266,700
B	101,600

WEIGHT, KG 69,853

MANUFACTURER [TORRINGTON](#)

INTERCHANGE

ROLLWAY	AT-753
ANDREWS	RTWH-753
INA	RTW-753