

GLRSW 4 FLURO

Spherical plain bearings

TYPE: Plain bearings, Spherical plain bearings and rod ends, Radial spherical plain bearings, Maintenance free, Series GLRSW (FLURO), corrosion-resistant

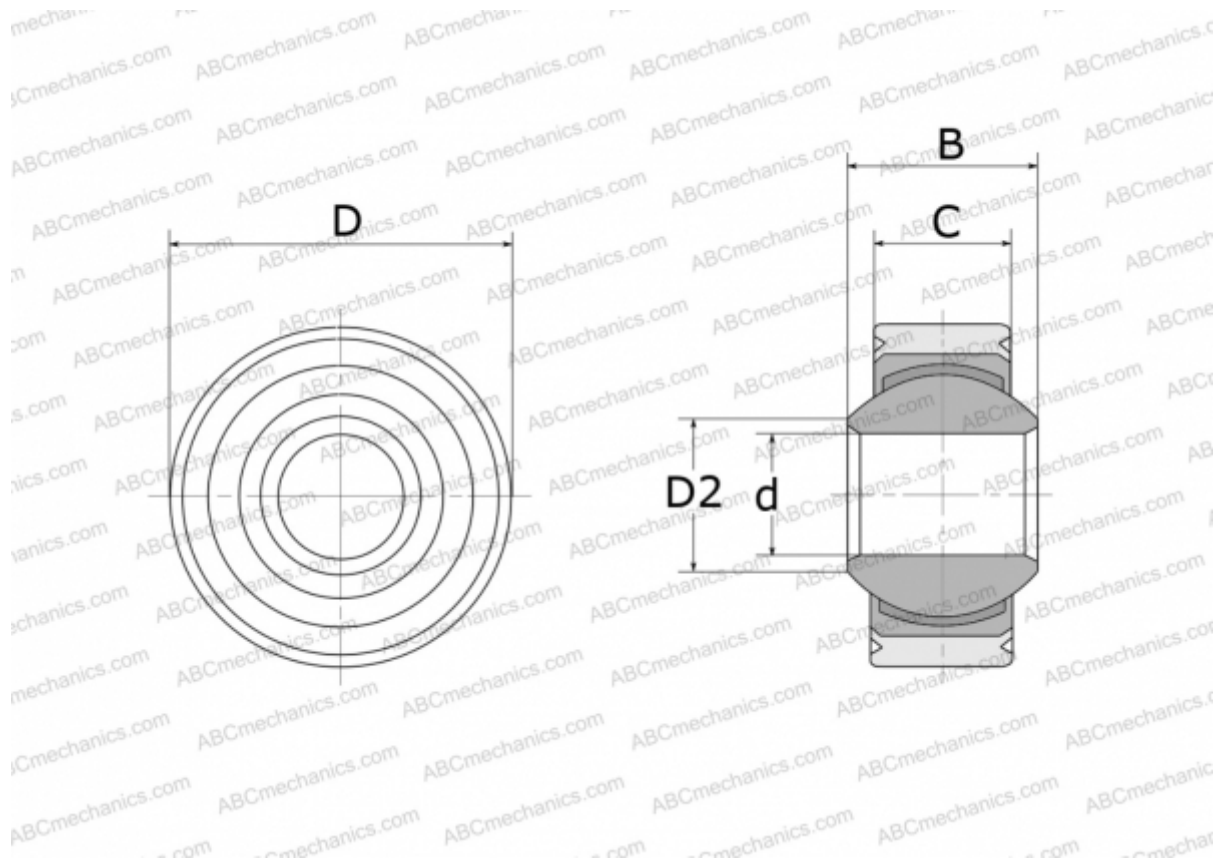

Technical specification

DIMENSIONS, MM

d	4,000
D	14,000
D2	6,500
B	7,000
C	5,250

WEIGHT, KG 0,005

MANUFACTURER [FLURO](#)