

GLRSW 8 FLURO

Spherical plain bearings

TYPE: Plain bearings, Spherical plain bearings and rod ends, Radial spherical plain bearings, Maintenance free, Series GLRSW (FLURO), corrosion-resistant

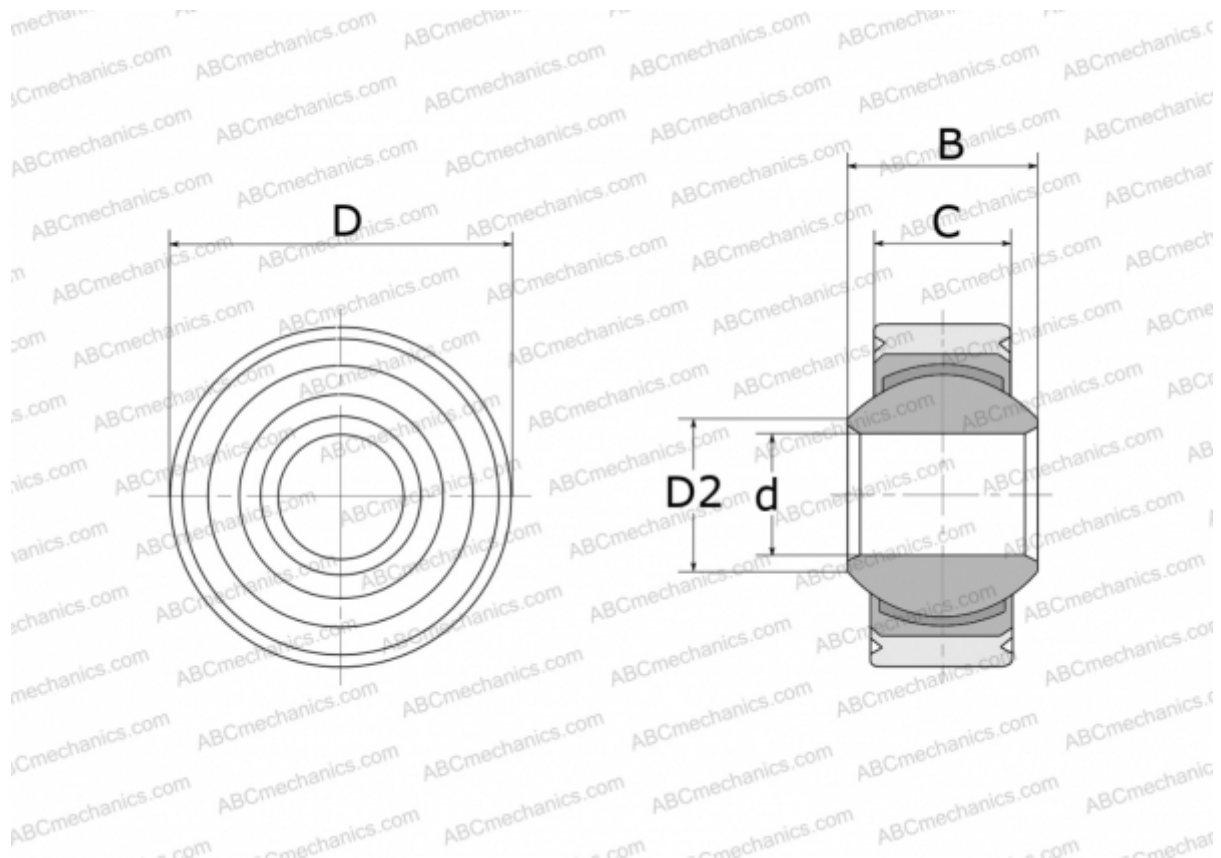

Technical specification

DIMENSIONS, MM

d	8,000
D	22,000
D2	10,400
B	12,000
C	9,000

WEIGHT, KG 0,023

MANUFACTURER [FLURO](#)