

GLRSW 20 FLURO

Spherical plain bearings

TYPE: Plain bearings, Spherical plain bearings and rod ends, Radial spherical plain bearings, Maintenance free, Series GLRSW (FLURO), corrosion-resistant

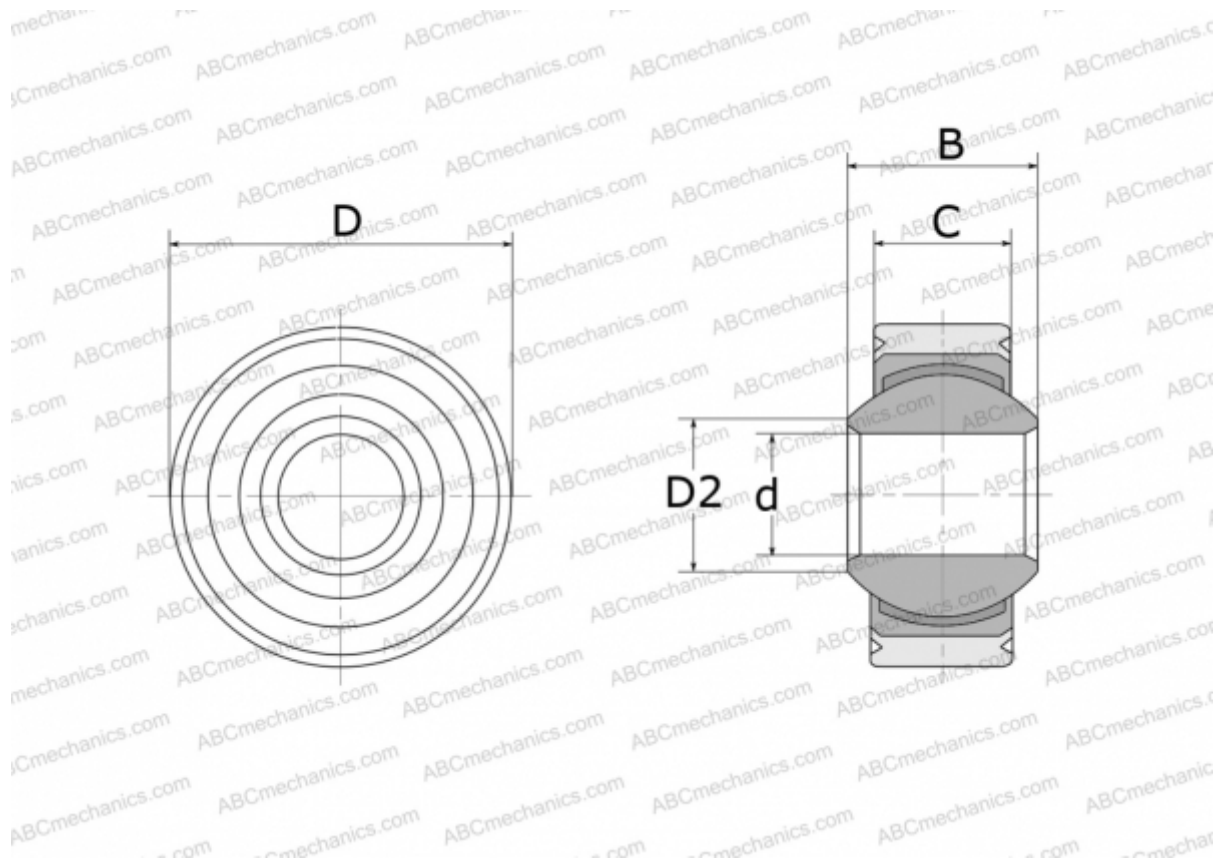

Technical specification

DIMENSIONS, MM

d	20,000
D	46,000
D2	24,300
B	25,000
C	18,000

WEIGHT, KG 0,200

MANUFACTURER [FLURO](#)