

GE 6 EC-NIRO FLURO

Spherical plain bearings

TYPE: Plain bearings, Spherical plain bearings and rod ends, Radial spherical plain bearings, Maintenance free, Series GE..EC-NIRO (FLURO), corrosion-resistant

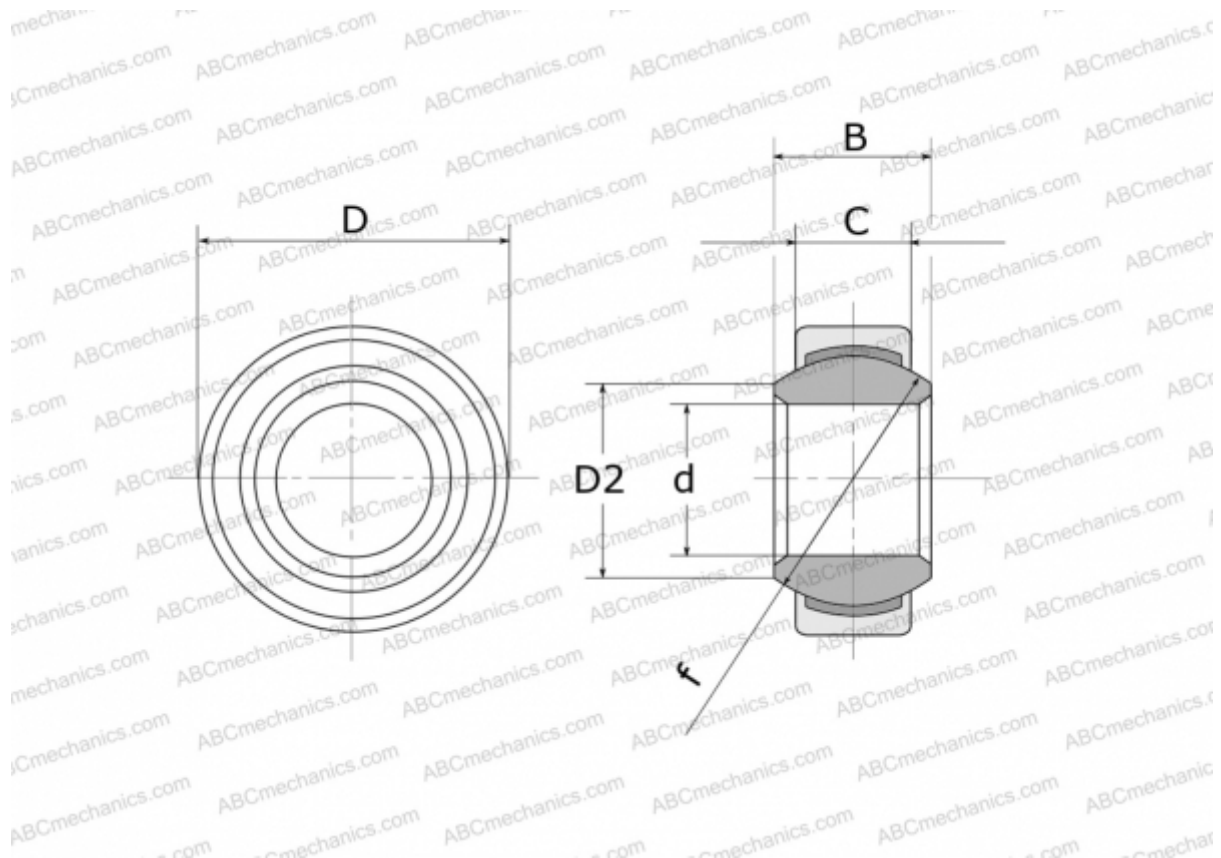

Technical specification

DIMENSIONS, MM

d	6,000
D	14,000
D2	8,000
B	6,000
f	10,000
C	4,000

WEIGHT, KG 0,004

MANUFACTURER [FLURO](#)