

GE 10 EC-NIRO FLURO

Spherical plain bearings

TYPE: Plain bearings, Spherical plain bearings and rod ends, Radial spherical plain bearings, Maintenance free, Series GE..EC-NIRO (FLURO), corrosion-resistant

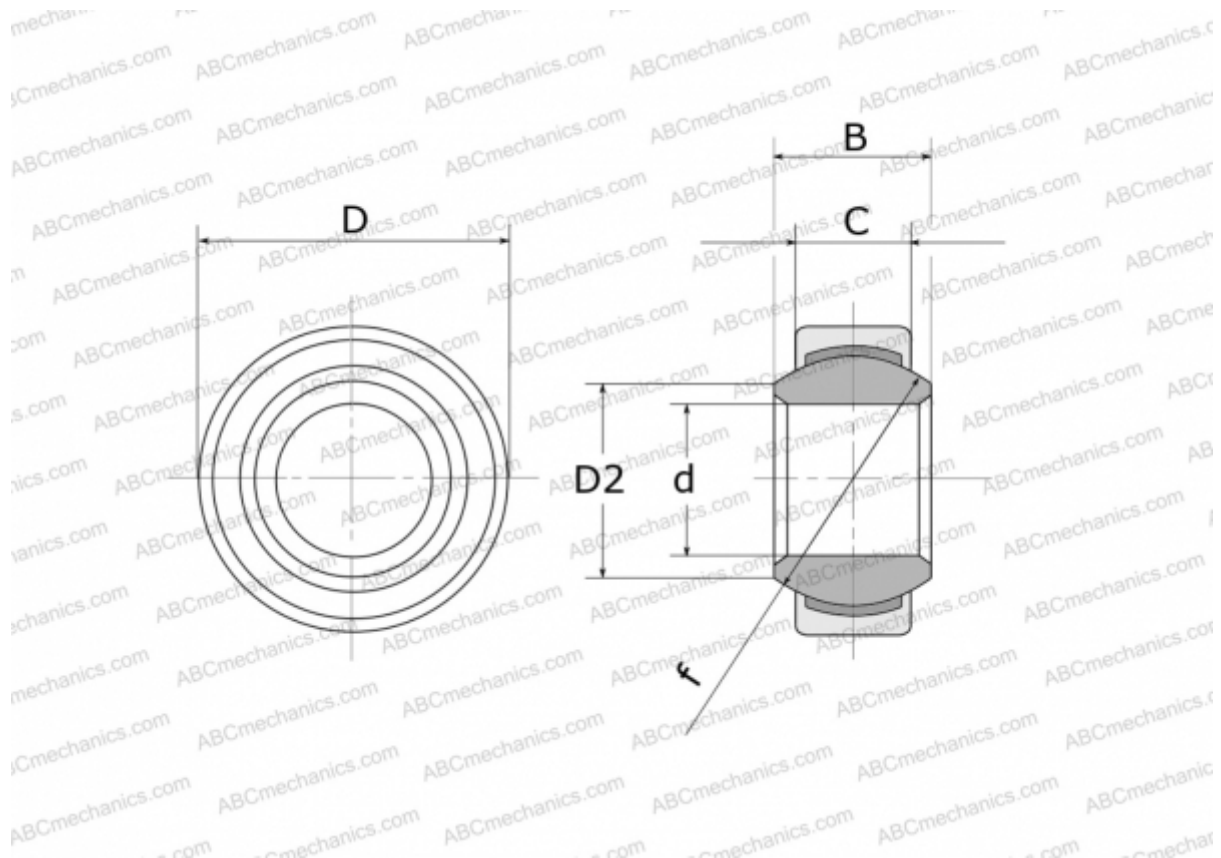

Technical specification

DIMENSIONS, MM

d	10,000
D	19,000
D2	13,200
B	9,000
f	16,000
C	6,000

WEIGHT, KG 0,011

MANUFACTURER [FLURO](#)