

GE 12 EC-NIRO FLURO

Spherical plain bearings

TYPE: Plain bearings, Spherical plain bearings and rod ends, Radial spherical plain bearings, Maintenance free, Series GE..EC-NIRO (FLURO), corrosion-resistant

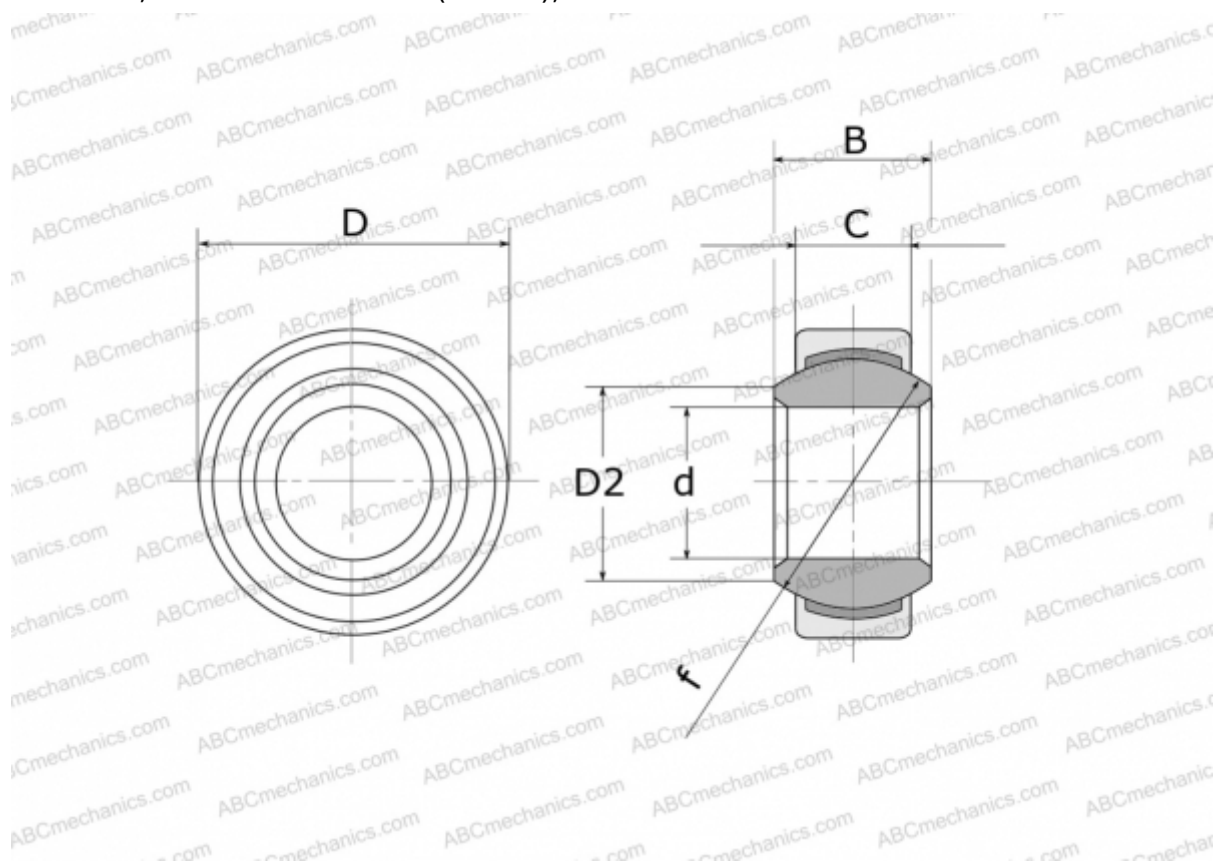

Technical specification

DIMENSIONS, MM

d	12,000
D	22,000
D2	14,900
B	10,000
f	18,000
C	7,000

WEIGHT, KG 0,016

MANUFACTURER [FLURO](#)