

GE 15 EC-NIRO FLURO

Spherical plain bearings

TYPE: Plain bearings, Spherical plain bearings and rod ends, Radial spherical plain bearings, Maintenance free, Series GE..EC-NIRO (FLURO), corrosion-resistant

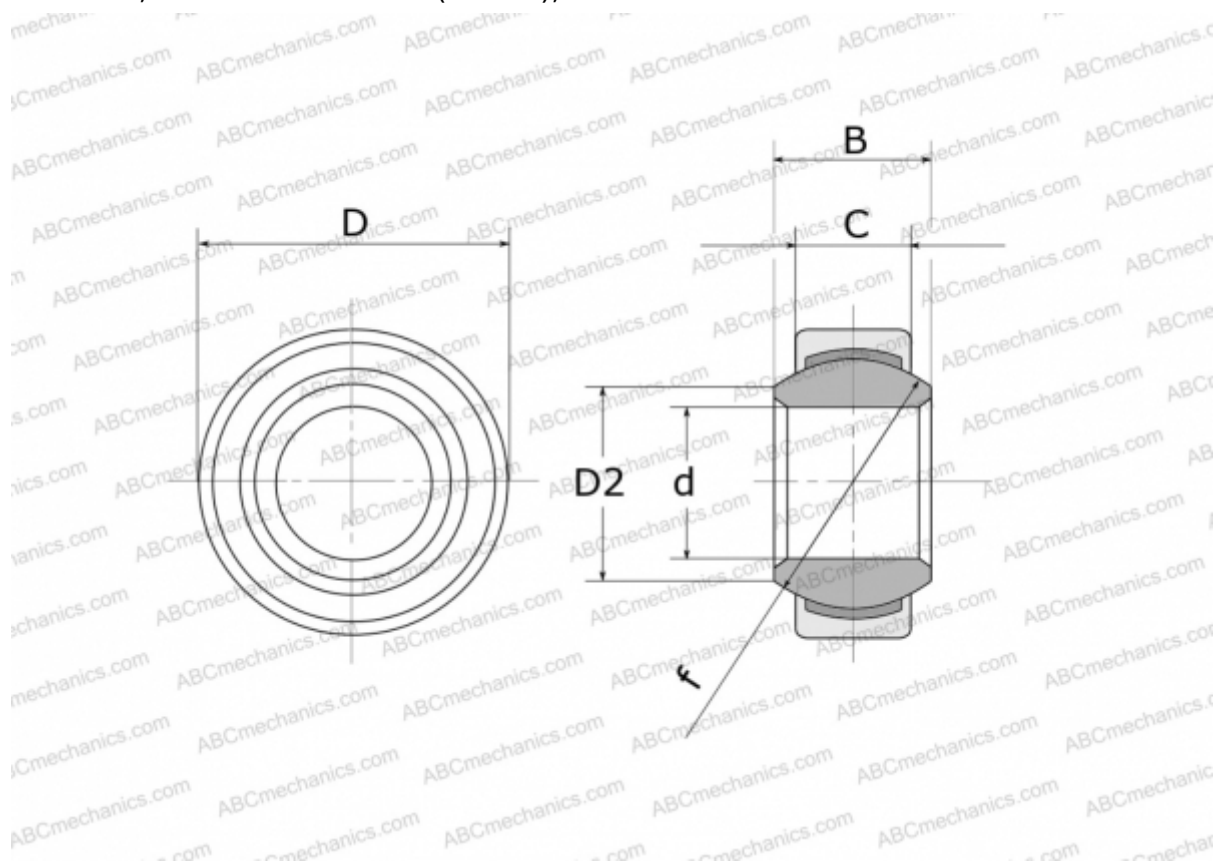

Technical specification

DIMENSIONS, MM

d	15,000
D	26,000
D2	18,400
B	12,000
f	22,000
C	9,000

WEIGHT, KG 0,026

MANUFACTURER [FLURO](#)