

GE 17 EC-NIRO FLURO

Spherical plain bearings

TYPE: Plain bearings, Spherical plain bearings and rod ends, Radial spherical plain bearings, Maintenance free, Series GE..EC-NIRO (FLURO), corrosion-resistant

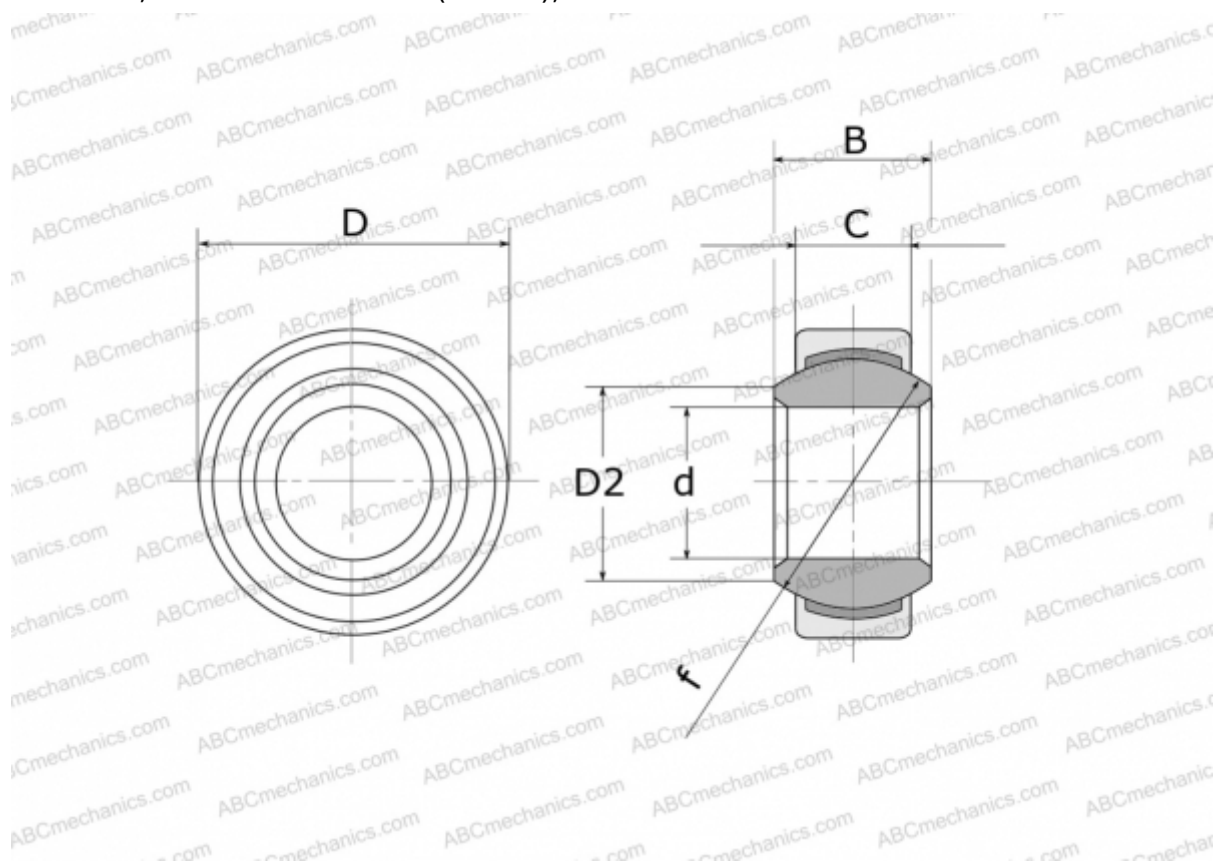

Technical specification

DIMENSIONS, MM

d	17,000
D	30,000
D2	20,700
B	14,000
f	25,000
C	10,000

WEIGHT, KG 0,038

MANUFACTURER [FLURO](#)