

GE 20 EC-NIRO FLURO

Spherical plain bearings

TYPE: Plain bearings, Spherical plain bearings and rod ends, Radial spherical plain bearings, Maintenance free, Series GE..EC-NIRO (FLURO), corrosion-resistant

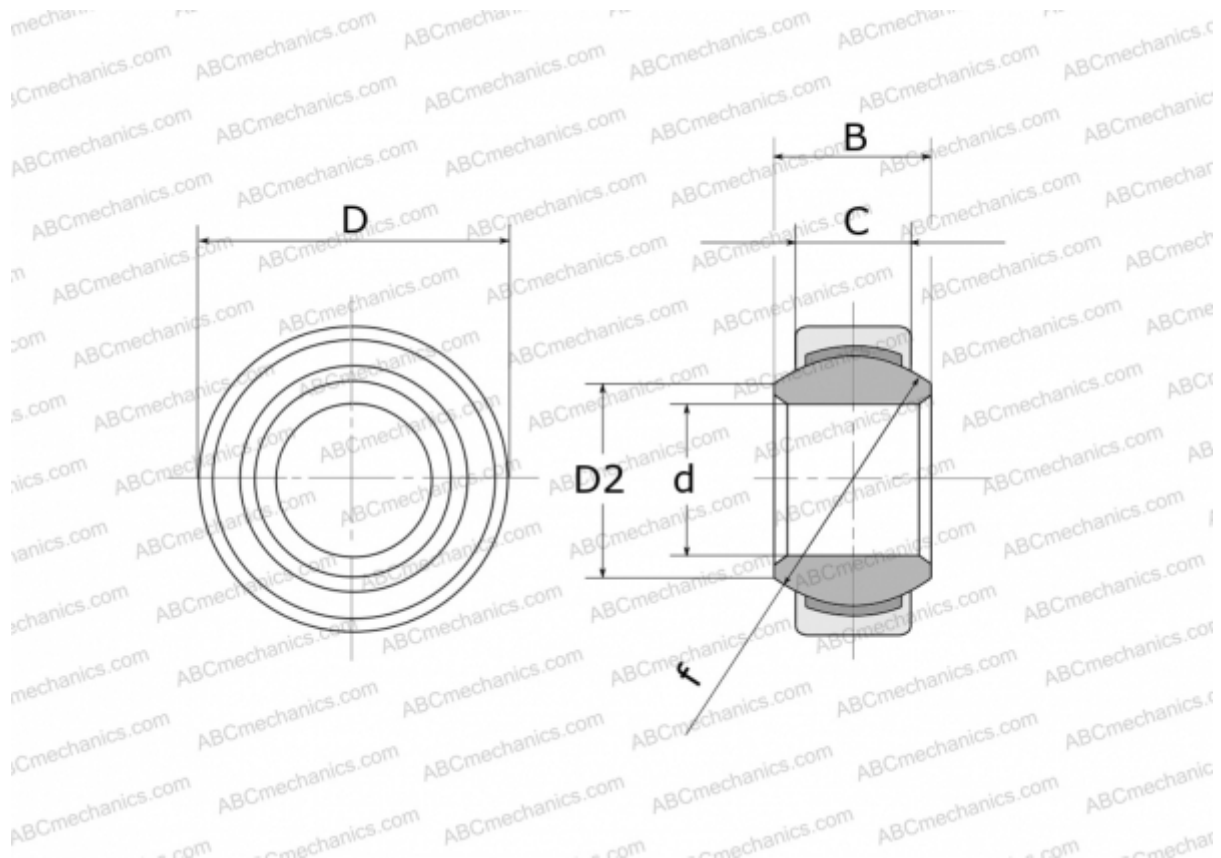

Technical specification

DIMENSIONS, MM

d	20,000
D	35,000
D2	24,200
B	16,000
f	29,000
C	12,000

WEIGHT, KG 0,061

MANUFACTURER [FLURO](#)