

GE 30 EC-NIRO FLURO

Spherical plain bearings

TYPE: Plain bearings, Spherical plain bearings and rod ends, Radial spherical plain bearings, Maintenance free, Series GE..EC-NIRO (FLURO), corrosion-resistant

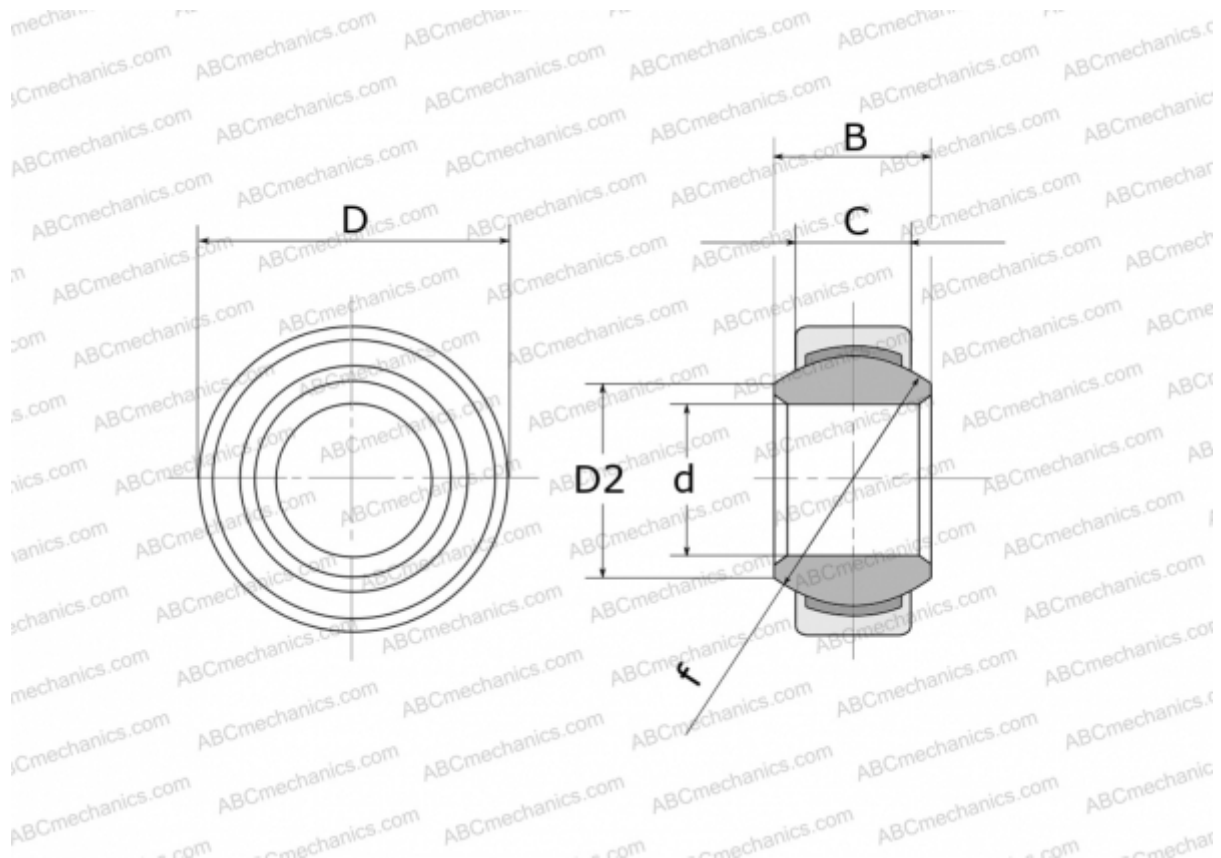

Technical specification

DIMENSIONS, MM

d	30,000
D	47,000
D2	34,200
B	22,000
f	40,700
C	18,000

WEIGHT, KG 0,140

MANUFACTURER [FLURO](#)