

GL 6 FLURO

Spherical plain bearings

TYPE: Plain bearings, Spherical plain bearings and rod ends, Radial spherical plain bearings, Requiring maintenance, Series GL (FLURO)

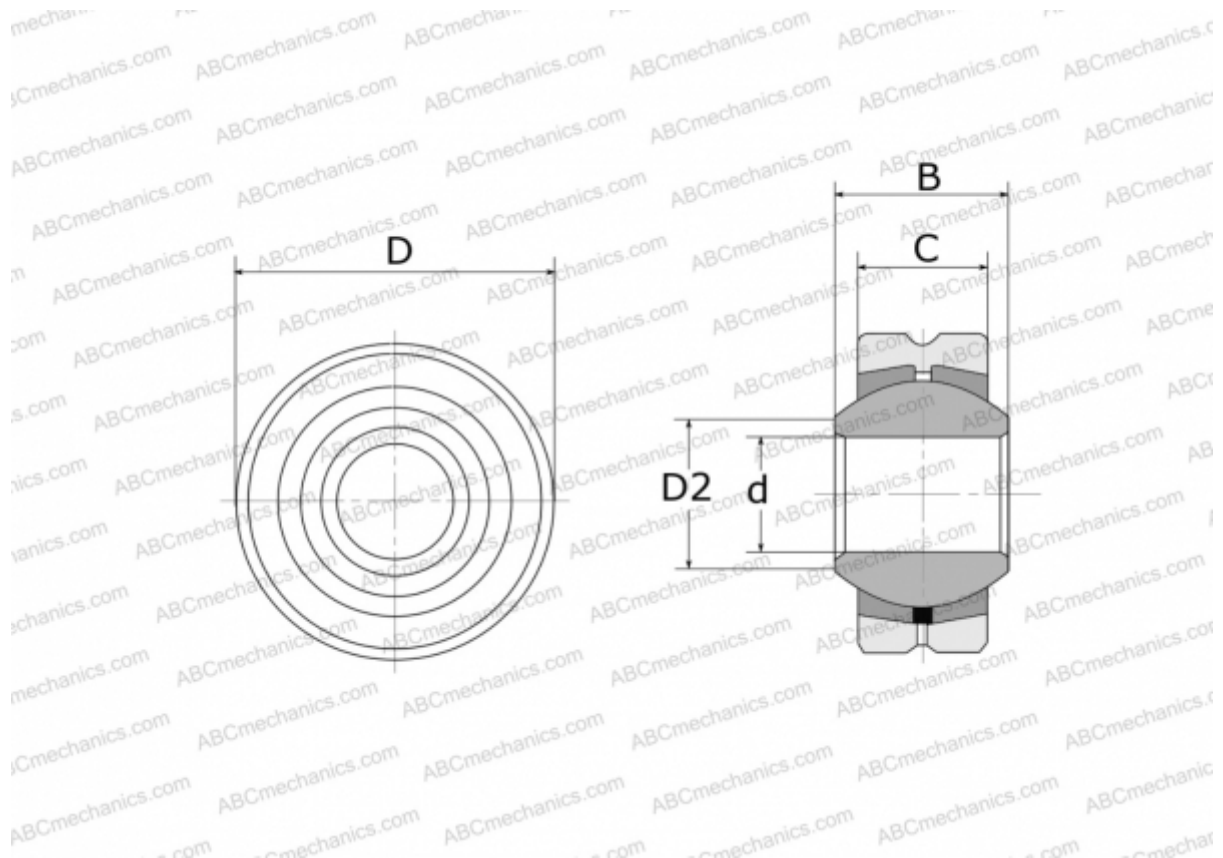

Technical specification

DIMENSIONS, MM

d	6,000
D	18,000
D2	8,900
B	9,000
C	6,750

WEIGHT, KG 0,012

MANUFACTURER [FLURO](#)