

GL 16 FLURO

Spherical plain bearings

TYPE: Plain bearings, Spherical plain bearings and rod ends, Radial spherical plain bearings, Requiring maintenance, Series GL (FLURO)

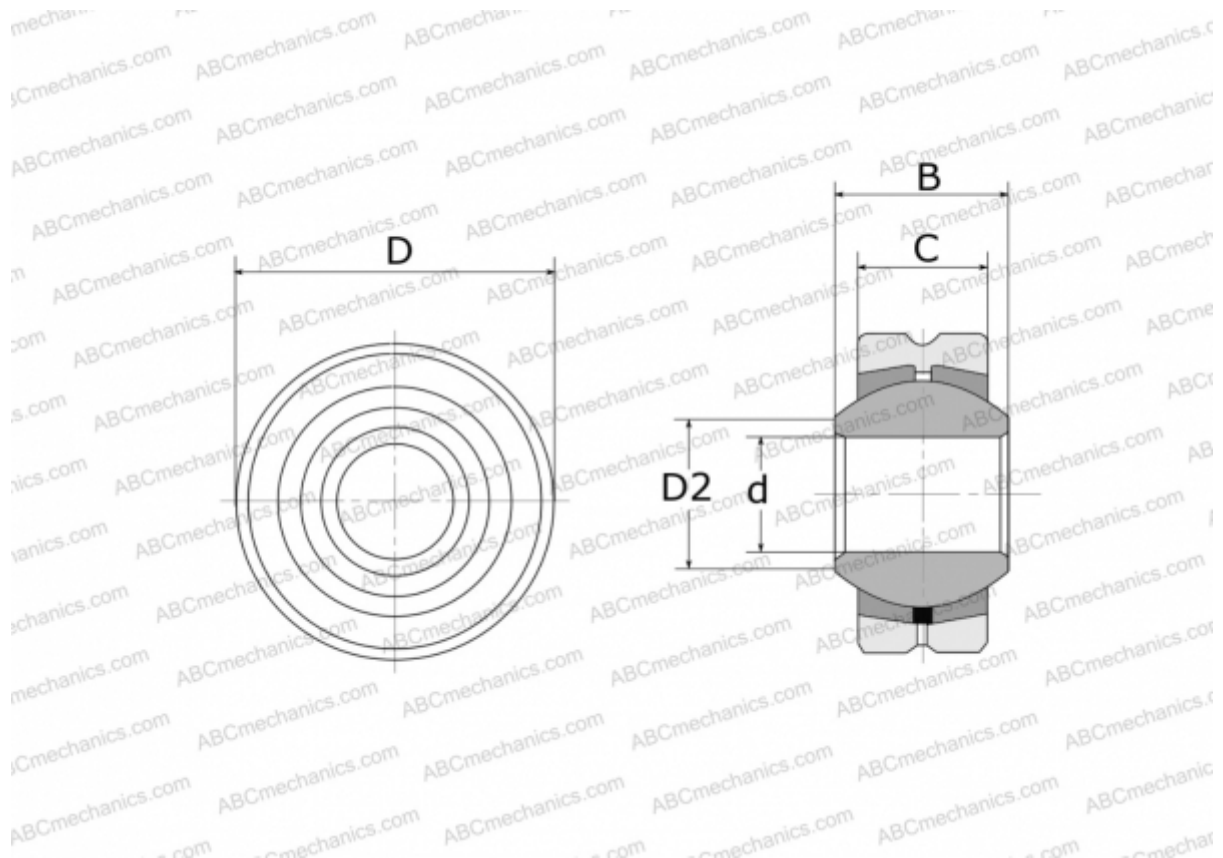

Technical specification

DIMENSIONS, MM

d	16,000
D	38,000
D2	19,300
B	21,000
C	15,000

WEIGHT, KG 0,115

MANUFACTURER [FLURO](#)