

GL 22 FLURO

Spherical plain bearings

TYPE: Plain bearings, Spherical plain bearings and rod ends, Radial spherical plain bearings, Requiring maintenance, Series GL (FLURO)

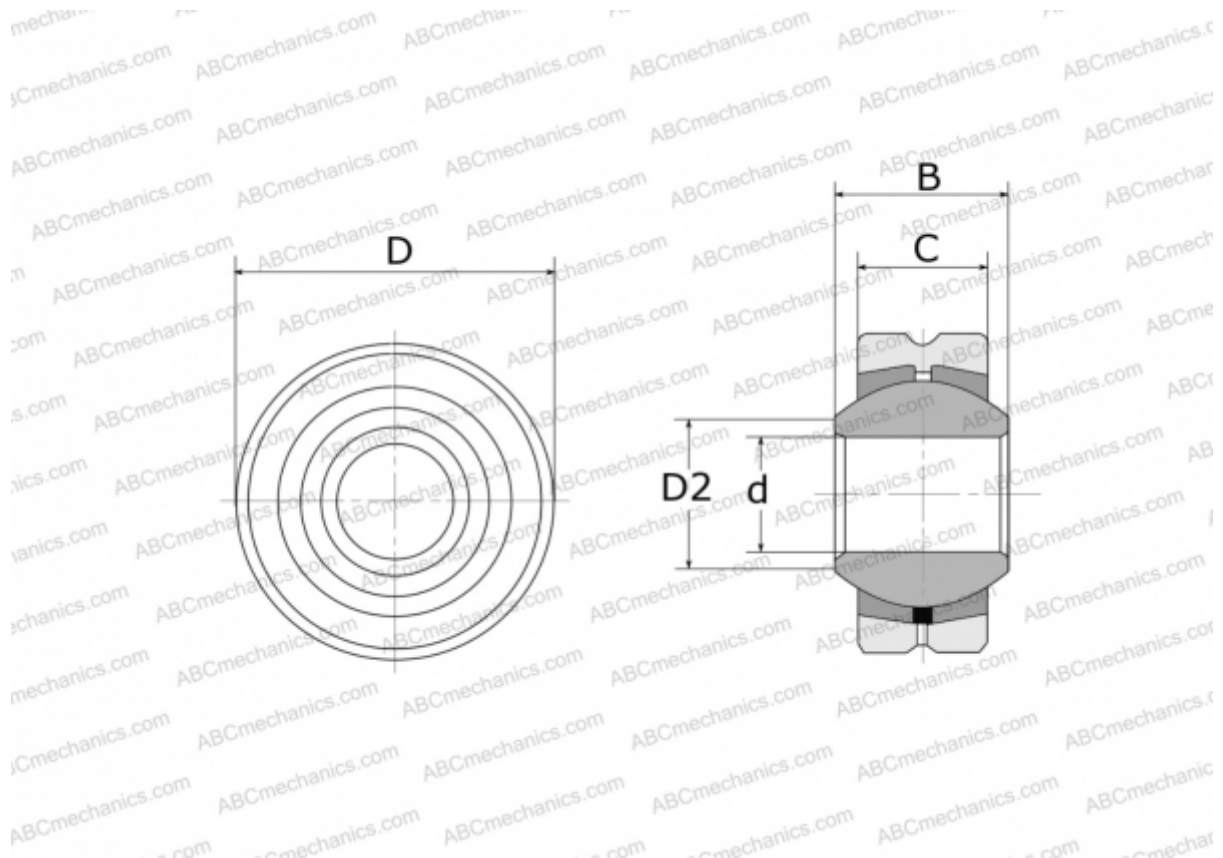

Technical specification

DIMENSIONS, MM

d	22,000
D	50,000
D2	25,800
B	28,000
C	20,000

WEIGHT, KG 0,270

MANUFACTURER [FLURO](#)