

GLXS 35 FLURO

Spherical plain bearings

TYPE: Plain bearings, Spherical plain bearings and rod ends, Radial spherical plain bearings, Requiring maintenance, Series GLXS (FLURO)

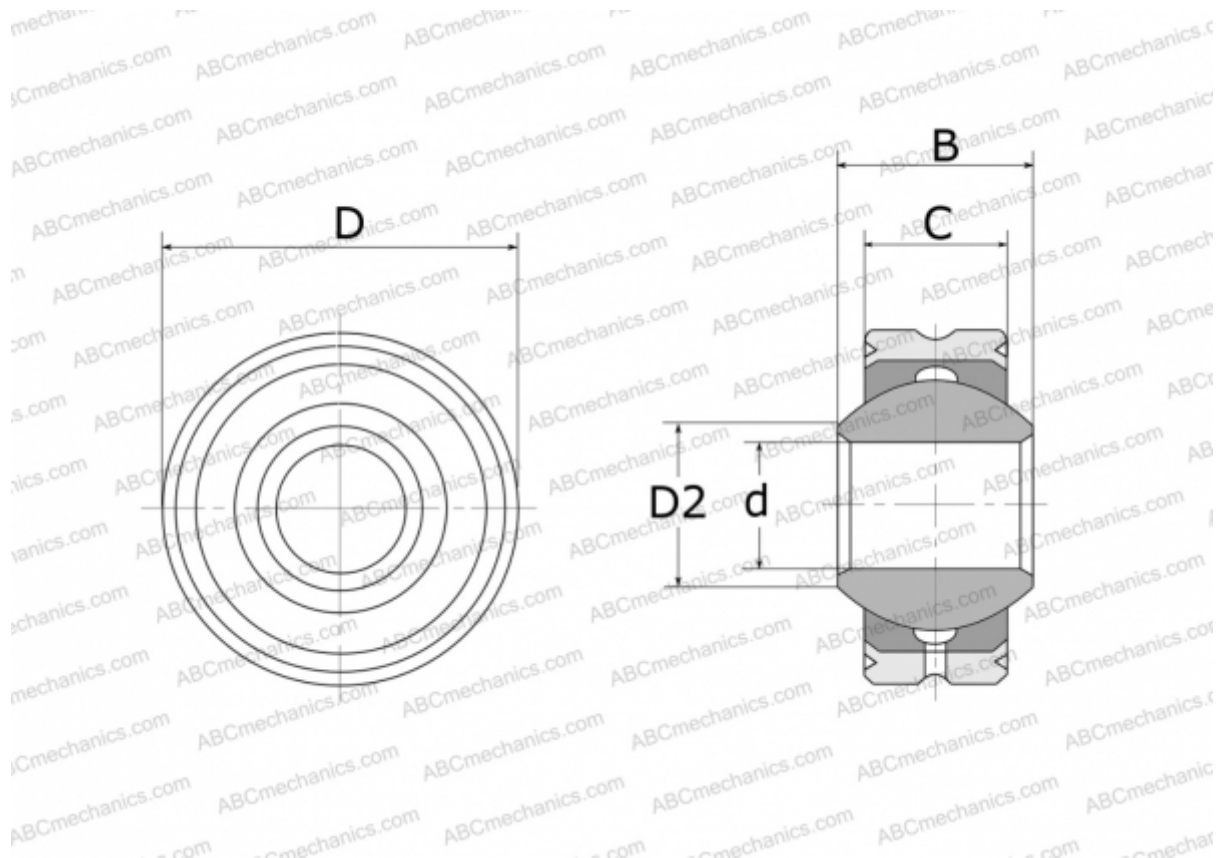

Technical specification

DIMENSIONS, MM

d	35,000
D	78,000
D2	37,700
B	43,000
C	28,000

WEIGHT, KG 0,850

MANUFACTURER [FLURO](#)