

GLRS 3 FLURO

Spherical plain bearings

TYPE: Plain bearings, Spherical plain bearings and rod ends, Radial spherical plain bearings, Requiring maintenance, Series GLRS (FLURO), corrosion-resistant

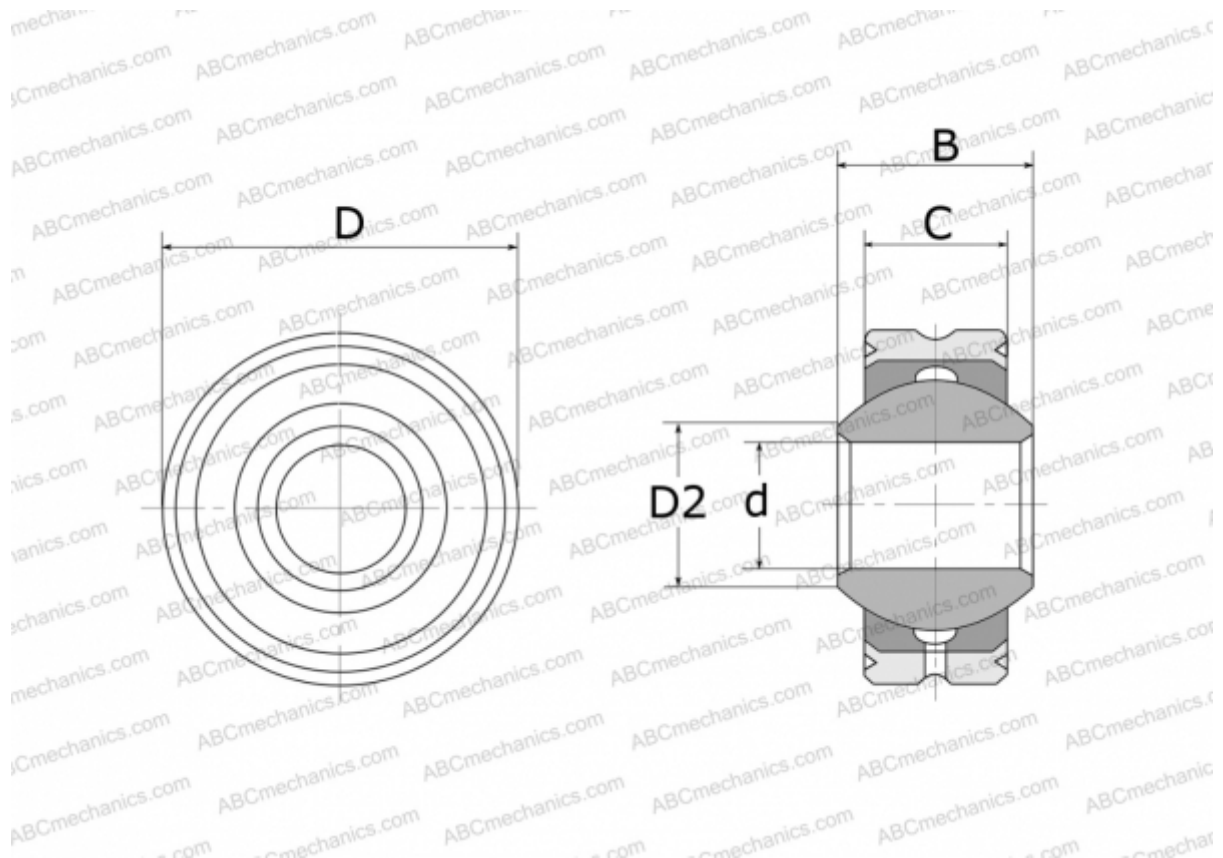

Technical specification

DIMENSIONS, MM

d	3,000
D	12,000
D2	5,100
B	6,000
C	4,500

WEIGHT, KG 0,005

MANUFACTURER [FLURO](#)