

GLRS 12 FLURO

Spherical plain bearings

TYPE: Plain bearings, Spherical plain bearings and rod ends, Radial spherical plain bearings, Requiring maintenance, Series GLRS (FLURO), corrosion-resistant

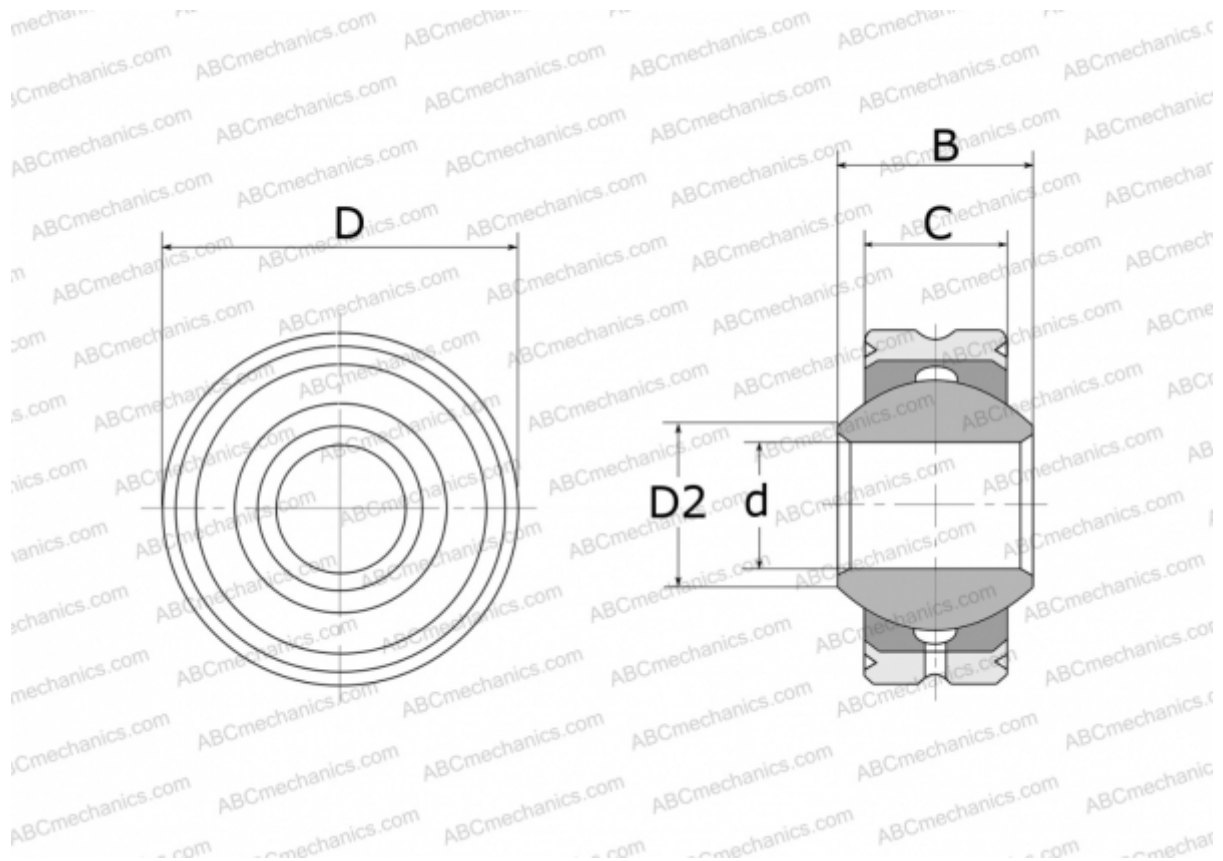

Technical specification

DIMENSIONS, MM

d	12,000
D	30,000
D2	15,400
B	16,000
C	12,000

WEIGHT, KG 0,058

MANUFACTURER [FLURO](#)