

GLRS 14 FLURO

Spherical plain bearings

TYPE: Plain bearings, Spherical plain bearings and rod ends, Radial spherical plain bearings, Requiring maintenance, Series GLRS (FLURO), corrosion-resistant

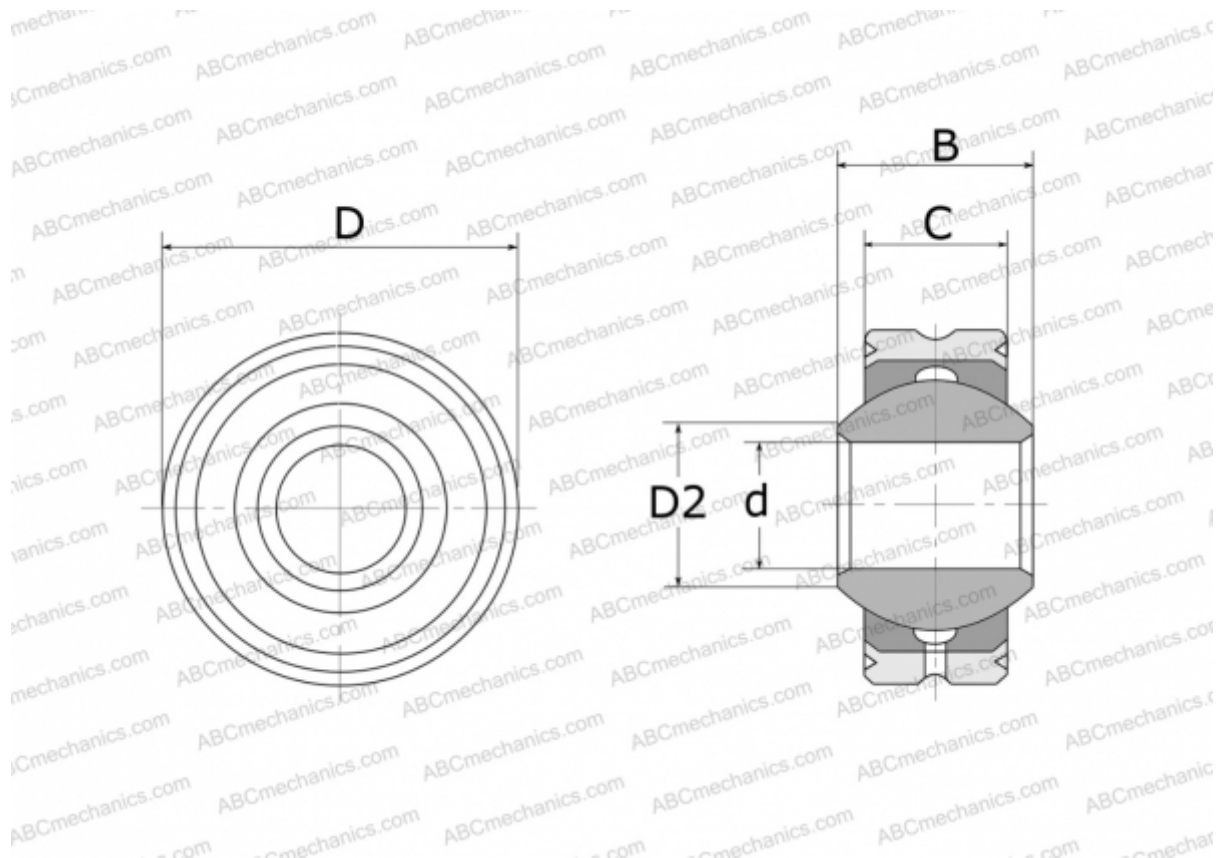

Technical specification

DIMENSIONS, MM

d	14,000
D	34,000
D2	16,800
B	19,000
C	13,500

WEIGHT, KG 0,083

MANUFACTURER [FLURO](#)