

GLRS 25 FLURO

Spherical plain bearings

TYPE: Plain bearings, Spherical plain bearings and rod ends, Radial spherical plain bearings, Requiring maintenance, Series GLRS (FLURO), corrosion-resistant

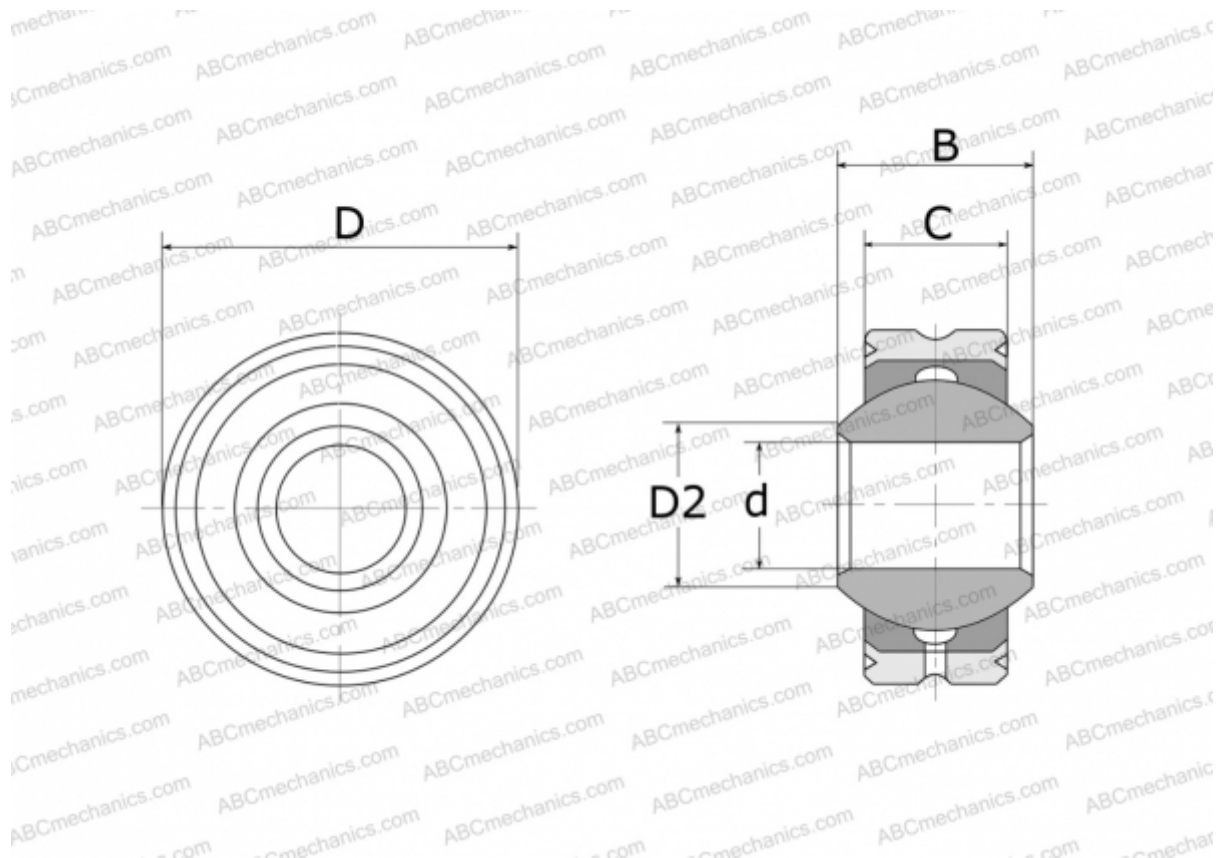

Technical specification

DIMENSIONS, MM

d	25,000
D	56,000
D2	29,600
B	31,000
C	22,000

WEIGHT, KG 0,375

MANUFACTURER [FLURO](#)