

GLRS 40 FLURO

Spherical plain bearings

TYPE: Plain bearings, Spherical plain bearings and rod ends, Radial spherical plain bearings, Requiring maintenance, Series GLRS (FLURO), corrosion-resistant

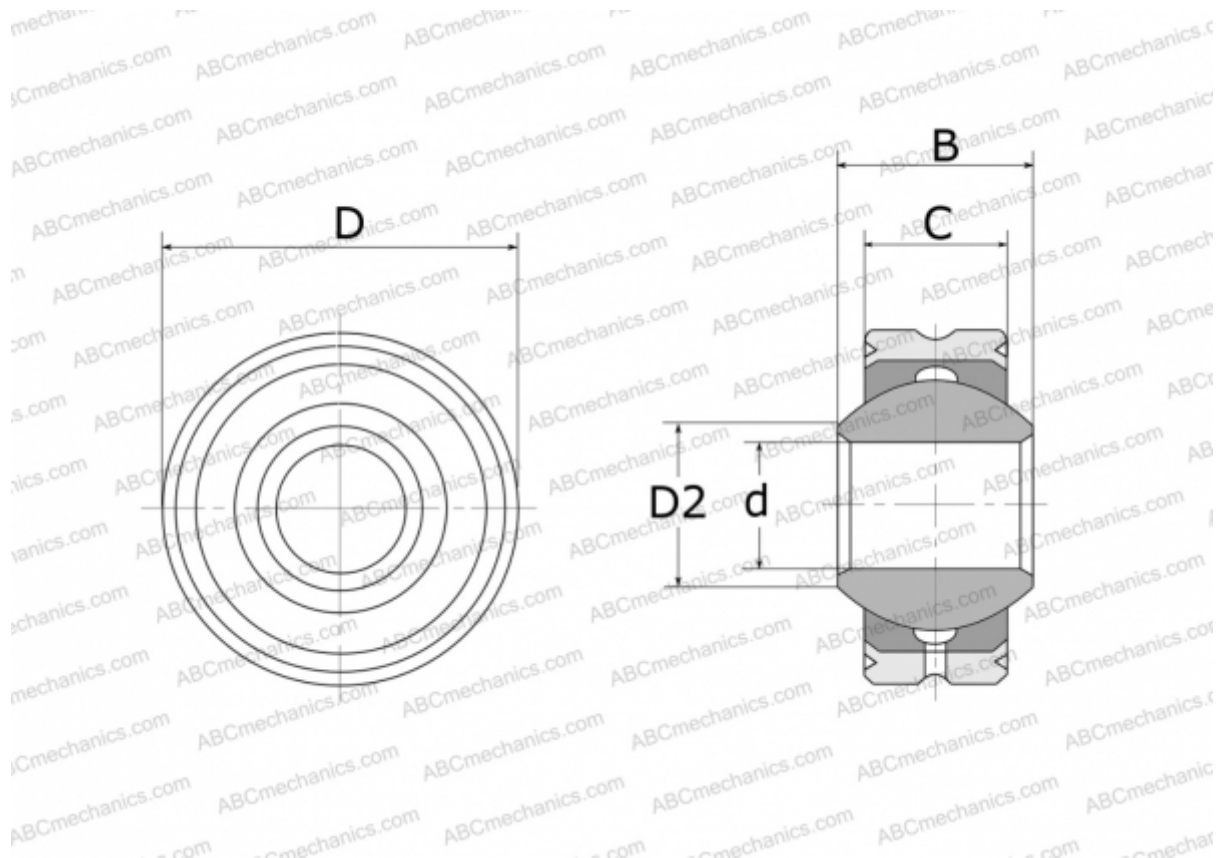

Technical specification

DIMENSIONS, MM

d	40,000
D	87,000
D2	44,200
B	49,000
C	35,000

WEIGHT, KG 1,400

MANUFACTURER [FLURO](#)