

GE 70 E FLURO

Spherical plain bearings

TYPE: Plain bearings, Spherical plain bearings and rod ends, Radial spherical plain bearings, Requiring maintenance, Series GE..E (FLURO)

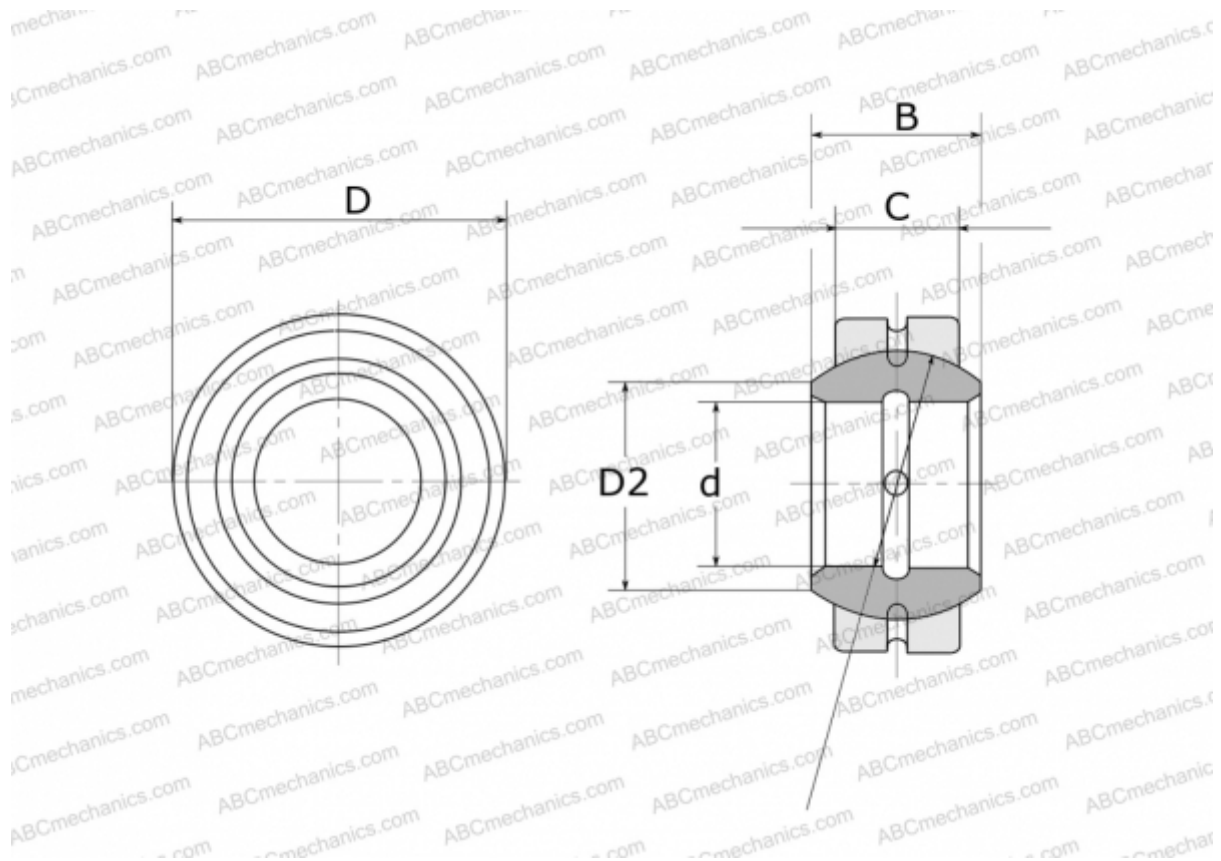

Technical specification

DIMENSIONS, MM

d	70,000
D	105,000
D2	77,800
B	49,000
f	92,000
C	40,000

WEIGHT, KG 1,570

MANUFACTURER [FLURO](#)