

## GE 80 E FLURO

Spherical plain bearings

TYPE: Plain bearings, Spherical plain bearings and rod ends, Radial spherical plain bearings, Requiring maintenance, Series GE..E (FLURO)

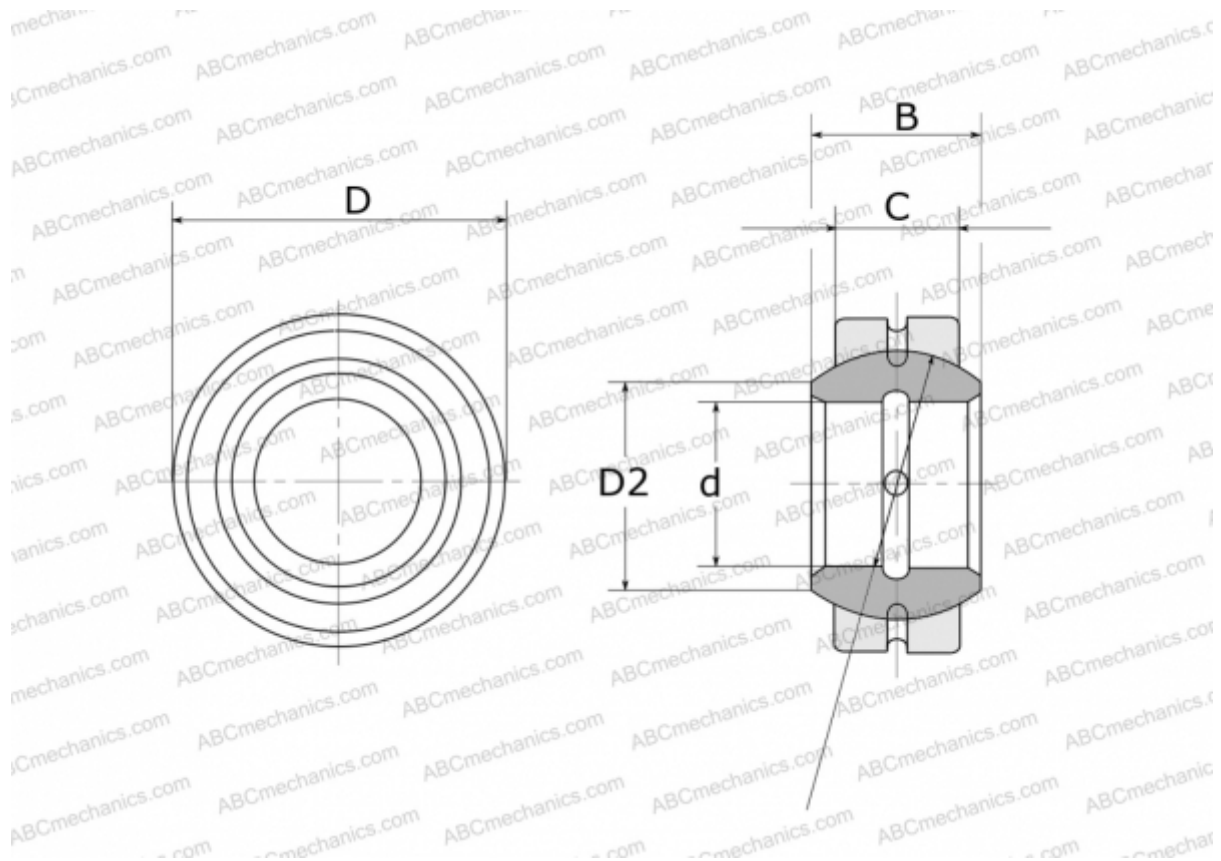

### Technical specification

#### DIMENSIONS, MM

d	80,000
D	120,000
D2	89,400
B	55,000
f	105,000
C	45,000

**WEIGHT, KG** 2,320

**MANUFACTURER** [FLURO](#)