

GE 90 E FLURO

Spherical plain bearings

TYPE: Plain bearings, Spherical plain bearings and rod ends, Radial spherical plain bearings, Requiring maintenance, Series GE..E (FLURO)

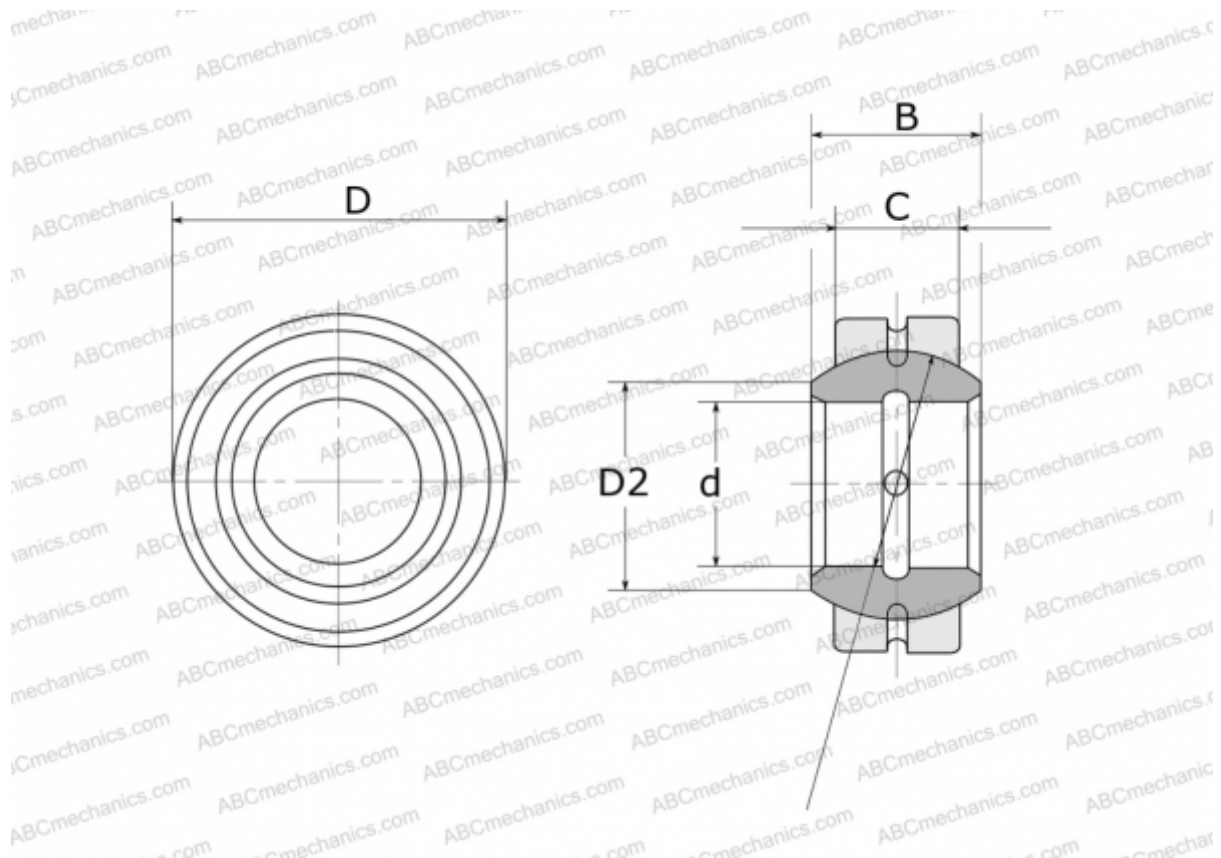

Technical specification

DIMENSIONS, MM

d	90,000
D	130,000
D2	98,100
B	60,000
f	115,000
C	50,000

WEIGHT, KG 2,790

MANUFACTURER [FLURO](#)